



**Family Locket**

# Who Were the Parents of Daniel Arnold?

Genealogy Research Report

**Nicole Dyer**

nicole@familyloket.com  
Family Locket Genealogists  
24 November 2020

## Table of Contents

Objective .....	2
Results Summary.....	2
Limitations .....	2
Autosomal DNA.....	2
Y-DNA.....	3
DNA Background Information.....	4
Autosomal DNA.....	4
Methodology.....	6
Genetic Networks .....	7
Pedigree Completeness .....	10
Y-DNA.....	10
Genealogical Background Information .....	11
Daniel and Lydia’s Children.....	12
Daniel’s Birthplace .....	12
Locality Information.....	16
Findings in Traditional Records.....	18
Amasa Arnold in Census Records.....	19
Probate & Land Records .....	21
Amos Arnold’s Family .....	22
Autosomal DNA Results .....	25
Clarissa Arnold .....	26
Charles Arnold.....	28
David Morise Arnold .....	31
Y-DNA Results .....	34
Conclusion.....	38
Future Research Suggestions.....	39
Attachment 1 – Amos Arnold Will Transcript.....	41
Attachment 2 – TT12 Y-DNA Matches .....	44

## Objective

Who was the father of Daniel Arnold? Daniel was born 6 August 1806 in Saratoga County, New York, and died 15 Jun 1881 in Henderson, Jefferson, New York, and married Lydia Willey.

## Results Summary

- Amasa Arnold of Exeter, Otsego, New York was found to be the probable father of Daniel Arnold.
- Charles Arnold, Clarissa (Arnold) Mason, Amos Arnold, and Elizabeth Arnold were found to be probable siblings of Daniel Arnold.
- Autosomal DNA matches were found to descend from Charles Arnold and Clarissa (Arnold) Mason.
- Autosomal DNA matches were found to descend from David Morise Arnold, possible cousin of Daniel.
- Thomas Arnold (1608-1674) of Watertown, Middlesex, Massachusetts was found to be a probable distant patrilineal ancestor of Daniel Arnold.
- Documents located were downloaded and shared in the following Google Drive folder: [Arnold Documents](#). To view the images at full resolution, download them to your computer first.

## Limitations

Only online records were consulted at this stage of research. Autosomal DNA and Y-DNA were used to find genetic evidence for the research objective. These types of DNA are both applicable to the objective but have limitations.

### Autosomal DNA

Autosomal DNA (atDNA) refers to DNA in the twenty-two pairs of autosomal chromosomes. The twenty-third pair of chromosomes includes the sex chromosomes (the X and Y chromosomes).<sup>1</sup> Autosomal DNA is inherited from a person's parents -- 50% from his father and 50% from his mother. Each individual inherits roughly 25% of their atDNA from each grandparent, and about 12.5% from each great-grandparent.<sup>2</sup> The amount of shared atDNA can predict the level of relationship between cousins by comparing the amount shared with statistical data about known cousin relationships.<sup>3</sup>

---

<sup>1</sup> "Autosomal DNA," *International Society of Genetic Genealogy Wiki* ([https://isogg.org/wiki/Autosomal\\_DNA](https://isogg.org/wiki/Autosomal_DNA) : last edited on 21 October 2020, at 22:09).

<sup>2</sup> "What is Inheritance?" video, *Learn.Genetics* (<https://learn.genetics.utah.edu/content/basics/inheritance/> : accessed 23 Nov 2020).

<sup>3</sup> Jennifer MacArthur and Robin Wirthlin, "How To Use Your Consumer DNA Test Results To Solve Your Family History Mysteries," *Family Locket* (<https://familylocket.com/how-to-use-your-consumer-dna-test-results-to-solve-your-family-history-mysteries/> : accessed 23 Nov 2020).

All second cousins will share a detectable amount of DNA, but not all third cousins and more distant cousins, due to recombination. Recombination is the “exchange of DNA segments between two copies of a chromosome (maternally inherited and paternally inherited).”<sup>4</sup> Recombination is random and does not result in an equal amount of inherited DNA from a person’s grandparents and more distant ancestors.<sup>5</sup> For example, an individual will always inherit 50% from each parent but might inherit 20% from their paternal grandfather and 30% from their paternal grandmother. Recombination occurs as a separate event for each child, so siblings will inherit different segments of DNA.<sup>6</sup>

Shared DNA is measured in centimorgans (cM).<sup>7</sup> The Shared cM Project is a collection of data showing the range of shared centimorgans associated with known relationships.<sup>8</sup> The amount of shared atDNA can be used accurately for confirming relationships up to the second cousin level when used in conjunction with historical records and genealogical information. For relationships more distant than second cousins the amount of shared DNA can indicate several possible relationships.<sup>9</sup> A larger group of test takers can be compared to study more distant cousin relationships for common ancestors further back in time.<sup>10</sup> Genetic genealogy experts recommend using atDNA to determine family relationships up to about 6-8 generations from the test taker.<sup>11</sup>

## Y-DNA

Y-DNA can be used to help determine patrilineal ancestors through many generations in time when used in conjunction with genealogical records. The Y chromosome is one of the sex chromosomes and is only found in males. It is passed from father to son mostly unchanged in each generation, without recombination.<sup>12</sup> Mutations occur occasionally when the Y-chromosome is passed down and this can help determine how much time has elapsed since two Y-DNA matches shared a common ancestor.<sup>13</sup> One of the limitations of Y-DNA testing is that it cannot distinguish between brothers, uncles, nephews, and so forth on the same patrilineal line to determine the ancestor of the test taker. It can, however,

---

<sup>4</sup> “Recombination,” *International Society of Genetic Genealogy Wiki* (<https://isogg.org/wiki/Recombination> : last edited on 14 April 2019, at 11:59).

<sup>5</sup> Blaine Bettinger, “How Do DNA Segments Get Smaller?” 31 January 2015, *The Genetic Genealogist* (<https://thegeneticgenealogist.com/2015/01/31/dna-segments-get-smaller/> : accessed 23 Nov 2020).

<sup>6</sup> MacArthur and Wirthlin, “How To Use Your Consumer DNA Test Results To Solve Your Family History Mysteries.”

<sup>7</sup> “Centimorgan,” *International Society of Genetic Genealogy Wiki* (<https://isogg.org/wiki/CentiMorgan> : last edited on 13 November 2020, at 12:08).

<sup>8</sup> Blaine Bettinger, “The Shared cM Project Version 4.0 (March 2020),” PDF document, *The Genetic Genealogist* (<https://thegeneticgenealogist.com/wp-content/uploads/2020/03/Shared-cM-Project-Version-4.pdf> : accessed 23 Nov 2020).

<sup>9</sup> “Autosomal DNA,” *International Society of Genetic Genealogy Wiki*.

<sup>10</sup> Ibid.

<sup>11</sup> MacArthur and Wirthlin, “How to Use Your Consumer DNA Test Results to Solve Your Family History Mysteries.” See also Blaine T. Bettinger and Debbie Parker Wayne, *Genetic Genealogy in Practice* (Arlington, VA: National Genealogical Society, 2016) 81-82.

<sup>12</sup> Bettinger and Wayne, *Genetic Genealogy in Practice*, 23.

<sup>13</sup> “Y Chromosome DNA tests,” *International Society of Genetic Genealogy Wiki* ([https://isogg.org/wiki/Y\\_chromosome\\_DNA\\_tests](https://isogg.org/wiki/Y_chromosome_DNA_tests) : last edited on 30 October 2020, at 20:52).

rule out a man as the common ancestor if there is significant mismatching between test takers. It can also confirm that a hypothesized ancestor is in the test taker's patrilineal line.<sup>14</sup>

Two types of Y-DNA tests are used for genetic genealogy: Short Tandem Repeat (STR) and Single Nucleotide Polymorphism (SNP). Y-STR tests look at certain markers along the Y chromosome for the number of repeats of nucleotide bases.<sup>15</sup> Y-SNP tests look at specific nucleotides at one or more locations on the Y chromosome.<sup>16</sup> The different Y-STR testing levels look at different numbers of markers. The Y-37 test looks at 37 markers, while the Y-111 test looks at 111 markers and can provide a higher resolution of matching if both individuals comparing have tested that many markers.

## DNA Background Information

### Autosomal DNA

A descendant of Daniel Arnold through his son Amos George Arnold will be referred to as Test Taker 1 (TT1). TT1 took an autosomal DNA test with *AncestryDNA* and *MyHeritage*. The *AncestryDNA* results were also uploaded to *GEDmatch* and *FamilyTreeDNA*. *AncestryDNA* has the largest database and was focused on for this phase of research. Future research could examine matches at *GEDmatch*, *MyHeritage* and *FamilyTreeDNA*. The DNA matches in figure 1 were located in TT1's *AncestryDNA* match list. They provide evidence for a biological relationship to Daniel Arnold. The DNA matches' attached family trees were used to find the most recent common ancestor. Future research could examine the parent-child links to be sure of their accuracy.

---

<sup>14</sup> Bettinger and Wayne, *Genetic Genealogy in Practice*, 25-26.

<sup>15</sup> *Ibid.*, 26.

<sup>16</sup> *Ibid.*, 33.

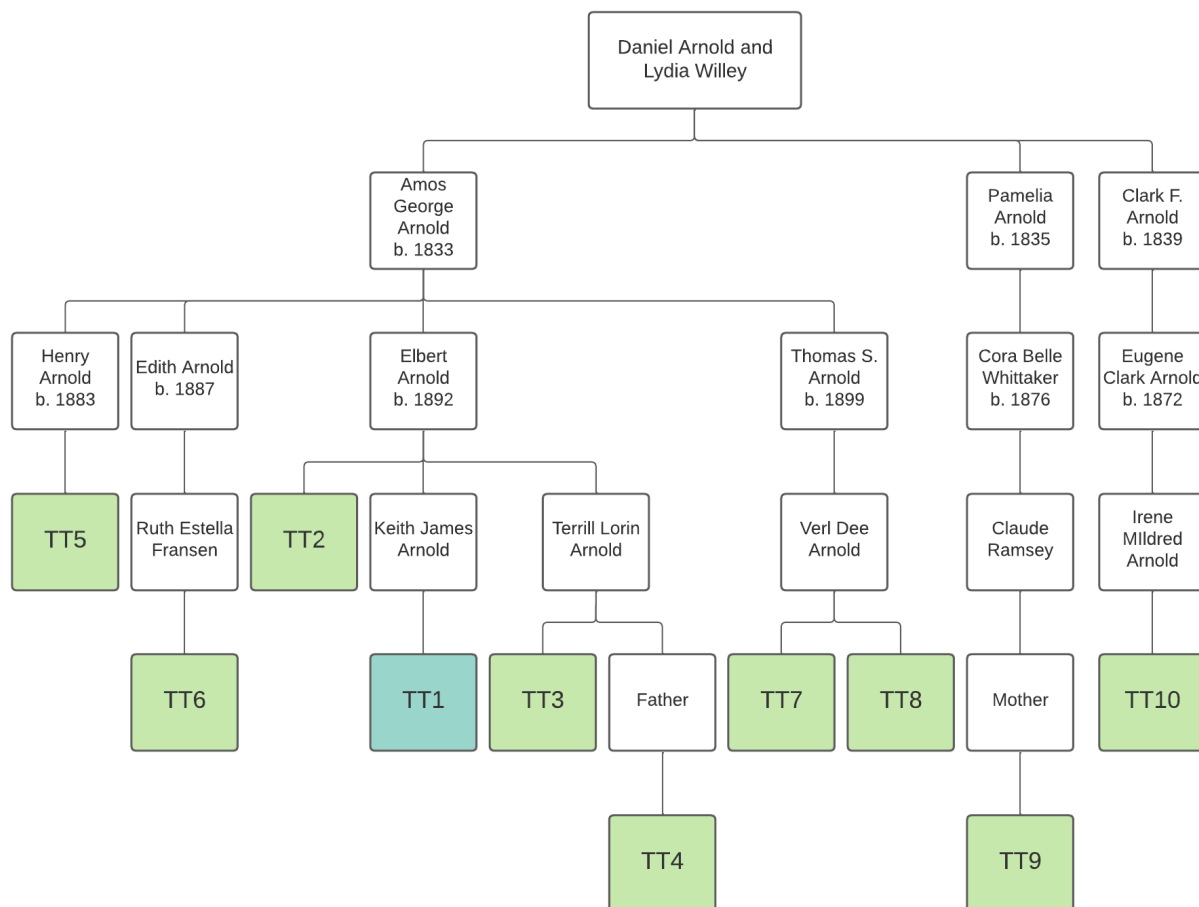

Figure 1 – TT1's AncestryDNA Matches  
Key: Teal = starting test taker; green = DNA match at AncestryDNA

DNA matches who descend from an ancestral couple that is also in the pedigree of the test taker provide evidence of a biological relationship of the test taker to that ancestor. The most recent common ancestor (MRCA) between two genetic matches is almost certainly the source of the shared DNA, unless the two share more than one common ancestor.<sup>17</sup>

Table 1 below shows the amount of shared DNA between the matches of TT1 in figure 1 who confirm his biological relationship to Daniel Arnold through his grandfather, Elbert Arnold, his great-grandfather Amos George Arnold, and 2<sup>nd</sup> great-grandfather Daniel Arnold.

<sup>17</sup> "Most Recent Common Ancestor," *International Society of Genetic Genealogy Wiki* ([https://isogg.org/wiki/Most\\_recent\\_common\\_ancestor](https://isogg.org/wiki/Most_recent_common_ancestor) : last edited on 31 January 2017, at 14:07).

DNA Match Name (MRCA)	Relationship to TT1	Shared cM	Shared cM Prediction for Relationship
TT2 (Elbert Arnold)	Uncle	1869 cM	1201-2282 cM (average 1741 cM)
TT3 (Elbert Arnold)	1st cousin	939 cM	396-1397 cM (average 866 cM)
TT4 (Elbert Arnold)	1st cousin once removed	416	102-980 cM (average 433 cM)
TT5 (Amos George Arnold)	1st cousin once removed	210	102-980 cM (average 433 cM)
TT6 (Amos George Arnold)	2nd cousin	73 cM	41-592 cM (average 229 cM)
TT7 (Amos George Arnold)	2nd cousin	354 cM	41-592 cM (average 229 cM)
TT8 (Amos George Arnold)	2nd cousin	308 cM	41-592 cM (average 229 cM)
TT9 (Daniel Arnold)	3rd cousin once removed	29 cM	0-192 (average 48 cM)
TT10 (Daniel Arnold)	3rd cousin	21 cM	0-234 (average 73 cM)

Sources for Table 1

"[TT1's] DNA Matches," *Ancestry* (<https://ancestry.com> : accessed 23 Nov 2020).

Blaine T. Bettinger and Jonny Perl, "The Shared CM Project 4.0 tool v4," *DNA Painter* (<https://dnainter.com/tools/sharedcmv4> : last updated 26th March 2020).

## Methodology

To discover the parents of a 2<sup>nd</sup> great-grandparent, third cousins who descend from the known ancestor are first identified. Using shared matches who share DNA with both the test taker and a match, potential fourth cousins who descend from the known ancestor's parents are identified. Matches who share DNA in the fourth cousin range (0-139 cM) and are shared matches with known 3<sup>rd</sup> cousins can provide genetic evidence for parents of Daniel Arnold.

Due to recombination, not all descendants of Daniel Arnold inherited the same segments of his DNA. DNA matches of more than one descendant of Daniel Arnold should be examined. The closer the descendant to the ancestor of interest, the more DNA they will share with them. The *AncestryDNA* match list of TT1's uncle, TT2, was shared with the researcher. TT2's matches are included in this study. He is one generation closer – the great grandson of Daniel Arnold. His second cousins can be used to locate third cousins who could descend from Daniel Arnold's parents and siblings. Matches who share DNA in the third cousin range (0-234) and are shared matches with known 2<sup>nd</sup> cousins can provide genetic evidence for the parents of Daniel Arnold.

## Genetic Networks

Genetic networks are groups of individuals who match a test taker and match each other. The individuals in a genetic network probably have a common ancestor.<sup>18</sup> In AncestryDNA, you can find groups of DNA matches who also match each other with their “shared matches” tool.

Network graphs are a way of illustrating genetic networks. When many nodes match each other, they are grouped into a cluster that likely share a common ancestor. A network graph was generated using TT1’s AncestryDNA matches who share between 15-260 cM.<sup>19</sup> See figure 2. The nodes in the graph are DNA matches of TT1. The lines between the nodes are shared match connections between two of TT1’s matches – meaning they match each other. Larger nodes indicate a larger amount of shared cM with the TT1. Colors and numbers were given to each cluster to identify them. Connections between clusters can indicate relationships between the common ancestors of the clusters. Some clusters may have descendants from more than one generation, i.e. a tester’s great-grandfather and great-grandmother as well as the great-grandfather’s parents.

TT1’s DNA matches TT5 and TT6, descendants of TT1’s great-grandfather, Amos George Arnold, were found in cluster 6. TT10, descendant of Daniel Arnold’s son Clark, was also found in cluster 6. TT9, a descendant of Daniel Arnold’s daughter Pamela, was found in cluster 17 but was closely connected to cluster 6 as well. Many lines connecting group 6 and group 17 indicate a relationship between the cluster. This shows the relationship between the likely common ancestors of the clusters – Amos George Arnold (cluster 6) and his father, Daniel Arnold (cluster 17). Focusing on identification of the matches in cluster 17 would likely result in finding matches relevant to this project.

---

<sup>18</sup> Robin Wirthlin, “10 Ways to Group Your DNA Matches into Genetic Networks,” post, 11 June 2019, *Family Locket* (<https://familyloket.com/10-ways-to-group-your-dna-matches-into-genetic-networks/> : accessed 24 Nov 2020).

<sup>19</sup> Nicole Dyer, TT1 AncestryDNA Network Graph, 15-260 cM, illustration created with Gephi software, October 2020, files of Nicole Dyer, Tucson, Arizona.



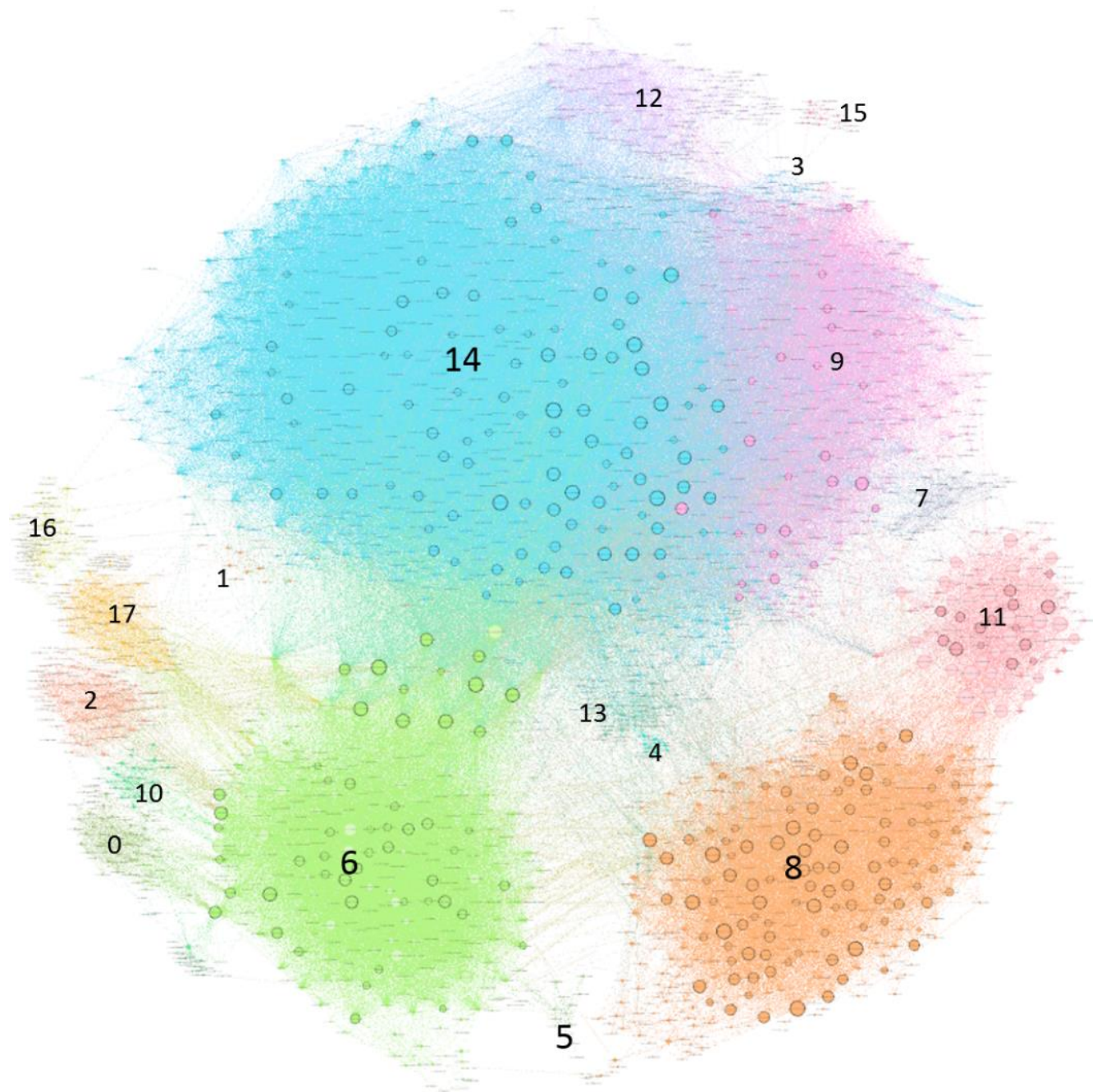

Figure 2 – Network Graph of TT1's Arnold's AncestryDNA matches from 15-260 cM

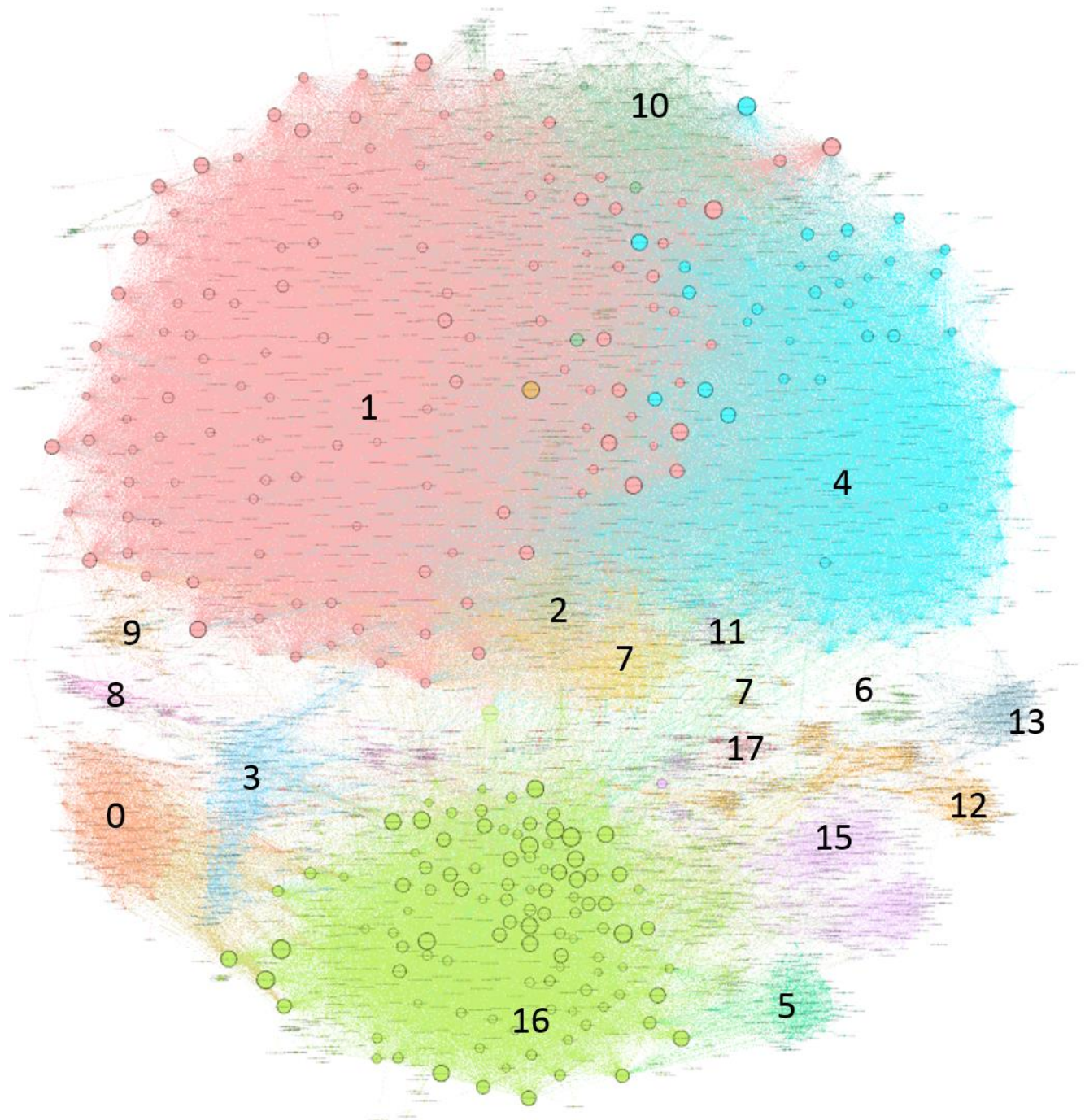

Figure 3 – Network graph of TT2’s AncestryDNA matches from 15-260 cM

A network graph was created for TT2’s AncestryDNA matches from 15-260 cM in figure 3.<sup>20</sup> TT11, a descendant of Amos George Arnold, was found in cluster 16. He was also closely connected to cluster 0.

<sup>20</sup> Nicole Dyer, TT2 AncestryDNA Network Graph, 15-260 cM, illustration created with Gephi software, October 2020, in the files of Nicole Dyer, Tucson, Arizona.



TT10, descendant of Daniel Arnold through his son Clark, was found in cluster 5, but was closely connected to cluster 16. TT9, descendant of Daniel Arnold's daughter Pamela, was found in cluster 15, but closely connected to cluster 16 as well. The common ancestor of Cluster 16 is probably Amos George Arnold and/or Daniel Arnold. Clusters connected to 16 include 5, 15, 12, 3, 8, and 0. Each of these clusters could contain matches relevant to the research project.

## Pedigree Completeness

Another limitation of using atDNA cousin matching for evidence of a genealogical relationship is the possibility for more than one common ancestor. If more than one common ancestor is found between two individuals, they are considered double cousins and the expected amount of shared DNA must be calculated and analyzed differently.<sup>21</sup> Test takers should extend their tree as far as possible to compare their tree with a match's tree and find a common ancestral couple. Knowing the test taker's pedigree completeness helps determine if a DNA match is related to the test taker in more than one way.

TT1 is the 2nd-great-grandson of Daniel Arnold and thus inherited about 6.25% of his DNA. TT1's family tree is complete to the 2nd great grandparent level. The only 3rd great grandparents which are not certain are Daniel Arnold's parents, although one user has added parents for him in the *FamilySearch Family Tree*.<sup>22</sup> All other branches of TT1's tree are from England, Scotland, France, and Switzerland, which reduces the chance that more than one common ancestor from the United States will be found for TT1's matches. TT1's only 2nd great-grandparents in the United States before 1830 are Daniel Arnold and Lydia Willey.

TT2 is the great-grandson of Daniel Arnold and thus inherited about 12.5% of Daniel Arnold's DNA. His tree is complete to the great-grandparent level and almost complete at the 2nd-great-grandparents level, only missing Daniel Arnold's parents. The other branches of his tree come from England and Scotland.<sup>23</sup>

## Y-DNA

TT1 also took a Y-37 DNA test from *Family Tree DNA*. To determine if his atDNA *also* matches any of his Y-DNA matches, the Advanced Matching tool was used. Only one individual matched TT1 on both the Y-37 test and the atDNA test – TT1's first cousin, TT12. TT1's other Y-DNA matches do not share a detectable amount of autosomal DNA and are almost certainly more distant than second cousins.<sup>24</sup> TT12's Y-DNA results were shared with the researcher as screenshots. He tested 67 markers.

---

<sup>21</sup> Jayne Ekins, "Calculating the Pedigree Collapse Effect in Your DNA Matches," blog post, 4 Aug 2019, *Your DNA Guide* (<https://www.yourdnaguide.com/ydgblog/2019/7/26/calculating-the-pedigree-collapse-effect-in-your-dna-matches> : accessed 23 Nov 2020).

<sup>22</sup> Keith James Arnold and Mildred Violet Chandler pedigree, ID KWZS-VB9, parents of TT1, "Family Tree," *FamilySearch* (<https://www.familysearch.org/tree/pedigree/landscape/KWZS-VB9> : viewed 23 Nov 2020).

<sup>23</sup> "DNA Matches Tree," created by user p\_niederer, "Public Member Trees," database, *Ancestry* (<https://www.ancestry.com/family-tree/tree/104402822/family/pedigree?cfpid=180043609868> : accessed 23 Nov 2020).

<sup>24</sup> "Cousin Statistics," *International Society of Genetic Genealogy Wiki* ([https://isogg.org/wiki/Cousin\\_statistics](https://isogg.org/wiki/Cousin_statistics) : last edited on 8 November 2020, at 23:39).

## Genealogical Background Information

The parents of Daniel Arnold are unknown to his descendants. A *FamilySearch Family Tree* user has added Asa Amasa Arnold as the father of Daniel Arnold but did not include evidence of this relationship.<sup>25</sup> Daniel's headstone in Smithville Cemetery, Henderson, Jefferson County, New York, is weathered and difficult to read, but the *Find A Grave* memorial states he was born 6 August 1806 and died 16 Jun 1881.<sup>26</sup> A Smithville Cemetery transcription states Daniel was age 75 years, 10 months, 9 days when he died on June 16, 1881.<sup>27</sup> This age at death calculates a birthdate of 6 August 1806. Census records agree that Daniel was born in 1806.<sup>28</sup>

Daniel Arnold probably married his wife, Lydia, sometime before 1827 when their first child, Titus Arnold, was born.<sup>29</sup> Death records for children of Lydia agree that her maiden name was Willey.<sup>30</sup> Lydia was born in Otsego County, New York.<sup>31</sup> She died in 1856 and was buried in Smithville Cemetery in

---

<sup>25</sup> Daniel Arnold, ID LVGY-6BQ, "Family Tree," *FamilySearch* (<https://www.familysearch.org/tree/person/details/LVGY-6BQ> : viewed 18 Nov 2020). See also Asa Amasa Arnold, ID LH3F-CM6, "Family Tree," *FamilySearch* (<https://www.familysearch.org/tree/person/details/LH3F-CM6> : viewed 18 Nov 2020).

<sup>26</sup> *Find a Grave*, database and images (<https://www.findagrave.com/memorial/83032680/daniel-arnold> : accessed 13 November 2020), memorial page for Daniel Arnold (6 Aug 1806–16 Jun 1881), Find a Grave Memorial no. 83032680, citing Smithville Cemetery, Smithville, Jefferson County, New York, USA ; maintained by noelle nann fairbanks (contributor 46830790), headstone photo by Anne Cady (contributor 46985237).

<sup>27</sup> Mrs. Charles P. Gruman, "Smithville Cemetery, Town of Henderson, Jefferson Co., NY Part 1," headstone transcriptions, *New York Gen Web* (<http://jefferson.nygenweb.net/cemeteries/smithville01.htm> : accessed 19 Nov 2020).

<sup>28</sup> 1850 U.S. census, Jefferson County, New York, population schedule, Hounsfield, p. 279, dwelling/family 253, Daniell Arnold household; image, *FamilySearch* (<https://www.familysearch.org/ark:/61903/3:1:S3HT-DYQS-N91> : accessed 9 Nov 2020); citing National Archives microfilm publication M432, roll 514. Also 1865 New York state census, Jefferson County, Henderson, p. 35, dwelling 251, family 266, Daniel Arnold household; image, *FamilySearch* (<https://www.familysearch.org/ark:/61903/3:1:9392-9FSG-F3> : accessed 10 Nov 2020). Also 1870 U.S. Census, Jefferson Co., New York, population schedule, Henderson, p. 39, dwelling 322, family 325, Daniel Arnold household; database with images, *FamilySearch* (<https://www.familysearch.org/ark:/61903/3:1:S3HT-6QBJ-SL> : accessed 10 Nov 2020); citing NARA microfilm publication M593, roll 944. Also 1880 U.S. census, Jefferson County, New York, population schedule, Henderson, E.D. 119, p. 4, dwelling 29, family 32, Daniel Arnold household; image, *FamilySearch* (<https://www.familysearch.org/ark:/61903/3:1:33SQ-GYB2-9FZN> : accessed 13 Nov 2020); citing National Archives microfilm publication T9, roll 839.

<sup>29</sup> Titus was 62 years, 4 months old when he died on 5 January 1890. See *Find a Grave*, database and images (<https://www.findagrave.com/memorial/92933604/> : accessed 19 November 2020), memorial page for Titus Arnold (unknown–5 Jan 1890), Find a Grave Memorial no. 92933604, citing Sulphur Springs Cemetery, Sulphur Springs, Jefferson County, New York, USA ; Maintained by 47305175 (contributor 47305175), headstone photo by Tashalyn1309 (contributor 49624168).

<sup>30</sup> For example, see New York Department of Health, Bureau of Vital Statistics, Certificate of Death, Monroe County, no. 37345, Margaret E. Bosworth, 30 Aug 1909; digital image, "Great Amount of Information on Daniel Arnold," PDF document in the files of Bruce Arnold, p. 39. Also, New York Department of Health, Bureau of Vital Statistics, Certificate of Death, Jefferson County, no. 92437, Lucy Holden, 15 Jan 1905; digital image, "Great Amount of Information on Daniel Arnold," p. 55.

<sup>31</sup> 1855 New York state census, Jefferson County, population schedule, Hounsfield, E.D. 1, p. 3, dwelling 27, family 28, Daniel Arnold household; image, *FamilySearch* (<https://www.familysearch.org/ark:/61903/1:1:K6Q1-CR2> : accessed 9 Nov 2020).

Jefferson County, New York.<sup>32</sup> Family records and a Willey genealogy state that Lydia was the daughter of Titus Willey and Lucy Hungerford, of Connecticut.<sup>33</sup>

## Daniel and Lydia's Children

Daniel and Lydia had 13 children, according to family records:<sup>34</sup>

1. Titus Arnold, b. 1827 in Redfield, Oswego, New York
2. Amasa Arnold, b. 21 Aug 1829, Redfield, Oswego, New York
3. Wilson Henry Arnold, b. 16 Jun 1831, Redfield, Oswego, New York
4. Amos George Arnold, b. 12 Mar 1833, Redfield, Oswego, New York
5. Pamela Arnold b. 14 Feb 1835, Redfield, Oswego, New York
6. Elbert Arnold, b. 1837, Redfield, Oswego, New York
7. Clark F. Arnold, b. 2 Jan 1839, Sackets Harbor, Jefferson, New York
8. Margaret E. Arnold, b. 28 Feb 1841, Sackets Harbor, Jefferson, New York
9. Louisa C. Arnold, b. 26 Feb 1843, Sackets Harbor, Jefferson, New York
10. James K. Arnold b. 26 Feb 1846, Sackets Harbor, Jefferson, New York
11. Amanda Arnold b. 30 Jul 1847, d. 5 Aug 1847, Hounsfield, Jefferson, New York
12. Charles Arnold, b. 25 Mar 1849, Hounsfield, Jefferson, New York, d. 14 Jul 1865
13. Lucy Arnold, b. 19 Nov 1851, Hounsfield, Jefferson, New York

Eleven of their children were listed as his heirs in 1881 when Daniel's daughter Pamela applied to the surrogate court to probate his will on 24 June 1881.<sup>35</sup> The Surrogate's Court in New York handles probate cases including the administration of estates and the probate of wills.<sup>36</sup>

## Daniel's Birthplace

Census records in which Daniel was the head of household, and probably the informant, report that his birthplace was New York, except the 1880 census, which states Massachusetts as his and his parents' birthplaces.<sup>37</sup> In the 1880 census, Daniel's adult son, Wilson, and daughter-in-law were living with him.

---

<sup>32</sup> *Find a Grave*, database and images (<https://www.findagrave.com/memorial/83032825/> : accessed 19 November 2020), memorial page for Lydia Willey Arnold (30 Dec 1807–14 Oct 1856), Find a Grave Memorial no. 83032825, citing Smithville Cemetery, Smithville, Jefferson County, New York, USA ; Maintained by noelle nann fairbanks (contributor 46830790), headstone photo by Anne Cady (contributor 46985237).

<sup>33</sup> Salt Lake Temple Records, Book N, p. 178, no. 6382, Lydia Willey, index card; digital image, "Great Amount of Information on Daniel Arnold," p. 7. For Connecticut, see Henry Willey, *Isaac Willey of New London, Conn., and His Descendants* (New Bedford, Massachusetts: Henry Willey, 1888) 21-22; image copy, *Google Books* (<https://www.google.com/books> : accessed 19 Nov 2020). [Link](#)

<sup>34</sup> "Family Group Record," Daniel Arnold and Lydia Willey family and children, genealogy software report created 20 Jul 2007, "Great Amount of Information on Daniel Arnold," p. 10-11.

<sup>35</sup> Jefferson County, New York, Wills 20:229-232, Daniel Arnold, 24 June 1881; image, *FamilySearch* (<https://www.familysearch.org/ark:/61903/3:1:33SQ-GY CJ-KVP> : accessed 19 Nov 2020).

<sup>36</sup> "New York Surrogate's court," *Wikipedia* ([https://en.wikipedia.org/wiki/New\\_York\\_Surrogate%27s\\_Court](https://en.wikipedia.org/wiki/New_York_Surrogate%27s_Court) : last edited on 19 August 2020, at 02:31 UTC).

<sup>37</sup> 1880 U.S. census, Jefferson Co., New York, pop. sch., Henderson, E.D. 119, p. 4, dwell. 29, fam. 32, Daniel Arnold household.

Either of them could have informed the enumerator about Daniel's place of birth. They may not have known where Daniel was born.

The New York state censuses all report that Daniel was born in Saratoga County, New York. See Table 2. This is probably more accurate since Daniel was likely the person informing the enumerator. Daniel was more likely than his wife and children to know his place of birth, however infants don't have memories of their birth. Even Daniel's knowledge of his birthplace was secondary information, told to him by his parents, and he could have remembered it incorrectly. The consistency with which Daniel Arnold reports Saratoga County, New York as his birthplace on several censuses where he was the head of household is strong evidence that it's accurate.

Table 2 – Daniel Arnold's Birthplace from Census Records

Birthplace	Head of Household / Informant	Source
New York	Daniel Arnold, head of household	1850 census <sup>a</sup>
Saratoga County, NY	Daniel Arnold, head of household	1855 NY state census <sup>b</sup>
Vermont	Wilson H. Arnold, head of household, Daniel's son	1860 census <sup>c</sup>
Saratoga County, NY	Daniel Arnold, head of household	1865 NY state census <sup>d</sup>
New York	Daniel Arnold, head of household	1870 census <sup>e</sup>
Saratoga County, NY	Daniel Arnold, head of household	1875 NY state census <sup>f</sup>
Massachusetts	Daniel Arnold, head of household, adult son Wilson and daughter-in-law living with him	1880 census <sup>g</sup>

a. 1850 U.S. census, Jefferson County, New York, population schedule, Hounsfield, p. 279, dwelling/family 253, Daniell Arnold household; image, *FamilySearch* (<https://www.familysearch.org/ark:/61903/3:1:S3HT-DYQS-N91> : accessed 9 Nov 2020).

b. 1855 New York state census, Jefferson County, population schedule, Hounsfield, E.D. 1, p. 3, dwelling 27, family 28, Daniel Arnold household; image, *FamilySearch* (<https://www.familysearch.org/ark:/61903/1:1:K6Q1-CR2> : accessed 9 Nov 2020).

c. 1860 U.S. census, Henderson County, New York, population schedule, Henderson, p. 86-87, dwelling 710, family 721, Wilson Arnold household; image, *FamilySearch* (<https://www.familysearch.org/ark:/61903/3:1:33S7-9BSD-SSKK> : accessed 13 Nov 2020); citing National Archives Microfilm publication M653, roll 762.

d. 1865 New York state census, Jefferson County, Henderson, p. 35, dwelling 251, family 266, Daniel Arnold household; image, *FamilySearch* (<https://www.familysearch.org/ark:/61903/3:1:9392-9FSG-F3> : accessed 10 Nov 2020).

e. 1870 U.S. Census, Jefferson Co., New York, population schedule, Henderson, p. 39, dwelling 322, family 325, Daniel Arnold household; database with images, *Ancestry* (<http://www.ancestry.com> : accessed 10 Nov 2020); citing NARA microfilm publication M593, roll 944.

f. 1875 New York state census, Jefferson County, Henderson, p. 2, dwelling 18, family 19, Daniel Arnold household; image, *FamilySearch* (<https://www.familysearch.org/ark:/61903/3:1:33S7-95MB-9FS1> : accessed 10 Nov 2020).

g. 1880 U.S. census, Jefferson County, New York, population schedule, Henderson, E.D. 119, p. 4, dwelling 29, family 32, Daniel Arnold household; image, *FamilySearch* (<https://www.familysearch.org/ark:/61903/3:1:33SQ-GYB2-9FZN> : accessed 13 Nov 2020); citing National Archives microfilm publication T9, roll 839.

Daniel's children's records mention several different states as the location of Daniel's birth, but most say New York. See Table 3. These conflicting records are probably due to the person providing the information for the census or death certificate not knowing where Daniel was born. They may have had a clue about where he or his parents were from, so these locations are clues. Three children's records stated Daniel was born in Massachusetts. Records from two children stated Daniel was born in Vermont. Some of the children's census records or death certificates left the father's birthplace blank or did not indicate a specific place within the United States. Those records are not included in Table 3.

Table 3 – Daniel Arnold’s Birthplace from his Children’s Records

Child	Father’s Birth	Head of Household/Informant	Source
Titus	New York	Titus Arnold, head of household	1880 census <sup>a</sup>
Amasa	New York	Amasa Arnold, head of household	1880 census <sup>b</sup>
Wilson	Massachusetts	Daniel Arnold, head of household	1880 census <sup>c</sup>
Wilson	Vermont	Geo A. Arnold (son of Wilson), head of house	1910 census <sup>d</sup>
Wilson	Vermont	J. Stuffleson – Wilson’s doctor, informant	Wilson’s death certificate <sup>e</sup>
Amos	Connecticut	Amos G. Arnold, head of household	1900 census <sup>f</sup>
Amos	Connecticut	Amos G. Arnold, head of household	1910 census <sup>g</sup>
Amos	New York	Earl Fransen, spouse of Amos’ daughter Edith	1920 census <sup>h</sup>
Pamelia	New York	Eli Whittaker, spouse of Daniel’s daughter Pamelia	1880 census <sup>i</sup>
Pamelia	New York	Byron Ramsey, spouse of Pamelia’s daughter Cora	1900 census <sup>j</sup>
Pamelia	Vermont	Frank Whittaker, son of Pamelia, head of house	1910 census <sup>k</sup>
William E.	New York	[William] Elbert Arnold, head of household	1880 census <sup>l</sup>
Clark	New York	Clark Arnold, head of household	1880 census <sup>m</sup>
Clark	Massachusetts	Unknown, maybe one of Clark F. Arnold’s children	Gazetteer of Jefferson County, NY <sup>n</sup>
Margaret	New York	Ambrose Bosworth – Margaret’s spouse, head	1880 census <sup>o</sup>
Margaret	New York	Lester A. Bosworth – Margaret’s spouse, informant	Daughter Margaret’s death certificate <sup>p</sup>
Louisa	New York	Theodore Ivory, head of household	1880 census <sup>q</sup>
James	New York	James Arnold, head of household	1880 census <sup>r</sup>
Lucy	Massachusetts	Winfield Holden, head of household	1880 <sup>s</sup>
Lucy	New Hampshire	Winfield Holden, head of household	1900 <sup>t</sup>
Lucy	Taberg, NY	Winfield Holden – Lucy’s husband, informant	Daughter Lucy’s death certificate <sup>u</sup>

a. 1880 U.S. census, Jefferson County, New York, population schedule, Hounsfield, E.D. 125, p. 9, dwelling/family 67, Titus Arnold household; image, *FamilySearch* (<https://www.familysearch.org> : accessed 18 Nov 2020); citing National Archives microfilm publication T9, roll 839. [Link](#)

b. 1880 U.S. census, Jefferson County, New York, population schedule, Henderson, E.D. 119, p. 4, dwelling 26, family 29, Amasa Arnold household; image, *FamilySearch* (<https://www.familysearch.org> : accessed 18 Nov 2020); citing National Archives microfilm publication T9, roll 839. [Link](#)

c. 1880 U.S. census, Jefferson County, New York, population schedule, Henderson, E.D. 119, p. 4, dwelling 29, family 32, Wilson Arnold in Daniel Arnold household; image, *FamilySearch* (<https://www.familysearch.org> : accessed 13 Nov 2020); citing National Archives microfilm publication T9, roll 839. [Link](#)

d. 1910 U.S. census, Hickory County, Missouri, population schedule, Weaubleau, E.D. 72, sheet 3A, dwelling 48, family 49, Wilson H. Arnold in Geo. A. Arnold household; image, *FamilySearch* (<https://www.familysearch.org> : accessed 18 Nov 2020); citing National Archives microfilm publication T624, roll 799. [Link](#)

e. Missouri State Board of Health, Bureau of Vital Statistics, Certificate of Death, Hickory County, no. 21636, Wittson [Wilson] H. Arnold, 16 July 1915; image, *Missouri Digital Heritage* (<https://www.sos.mo.gov> : accessed 13 Nov 2020). [Link](#)

f. 1900 U.S. census, Fremont County, Idaho, population schedule, Lyman Precinct, E.D. 55, sheet 16B, dwelling 263, household 273, Amos G. Arnold household; image, *FamilySearch* (<https://www.familysearch.org> : accessed 18 Nov 2020); citing National Archives microfilm publication T623, roll 223. [Link](#)

g. 1910 U.S. census, Fremont County, Idaho, population schedule, Lyman, E.D. 123, sheet 5B, dwelling 55, family 56, Amos G. Arnold household; image, *FamilySearch* (<https://www.familysearch.org> : accessed 18 Nov 2020); citing National Archives microfilm publication T624, roll 224. [Link](#)

h. 1920 U.S. census, Madison County, Idaho, population schedule, Rexburg, E.D. 197, sheet 3B, dwelling 31, family 35, Amos G. Arnold in Earl C. Fransen household; image, *FamilySearch* (<https://www.familysearch.org> : accessed 18 Nov 2020); citing National Archives microfilm publication T625, roll 293. [Link](#)

i. 1880 U.S. census, Jefferson County, New York, population schedule, Hounsfield, E.D. 126, p. 8, dwelling 80, family 84, Pamelia in Eli Whittaker household; image, *FamilySearch* (<https://www.familysearch.org> : accessed 18 Nov 2020); citing National Archives microfilm publication T9, roll 839. [Link](#)

j. 1900 U.S. census, Jefferson County, New York, population schedule, Henderson Town, E.D. 19, sheet 7B, dwelling 163, family 178, Pamelia Whittaker in Byron Ramsey household; image, *FamilySearch* (<https://www.familysearch.org> : accessed 18 Nov 2020); citing National Archives microfilm publication T623, roll 1041. [Link](#)

k. 1910 U.S. census, Jefferson County, New York, population schedule, Henderson, E.D. 26, Sheet 7B, dwelling 187, family 196, Pamelia Whittaker in Frank Whittaker household; image, *FamilySearch* (<https://www.familysearch.org> : accessed 18 Nov 2020); citing National Archives microfilm publication T624, roll 954. [Link](#)

l. 1880 U.S. census, Putnam County, New York, population schedule, Carmel, E.D. 76, p. 16, dwelling 132, family 157, Elbert Arnold household; image, *FamilySearch* (<https://www.familysearch.org> : accessed 18 Nov 2020); citing National Archives microfilm publication T9, roll 917. [Link](#)

m. 1880 U.S. census, Jefferson County, New York, population schedule, Hounsfield, E.D. 126, p. 9, dwelling 89, family 93, Clark Arnold household; image, *FamilySearch* (<https://www.familysearch.org> : accessed 18 Nov 2020); citing National Archives microfilm publication T9, roll 839. [Link](#)



n. Hamilton Child, *Geographical Gazetteer of Jefferson County, N. Y. 1684-1890* (Syracuse, NY: The Syracuse Journal Co., 1890) 513; image online, *Google Books* (<https://www.google.com/books> : accessed 18 Nov 2020). [Link](#). In the Town of Hounsfield Section, about Clark F. and Almira (Smith) Arnold's ancestry, it said, "Clark F. Arnold's father, Daniel, was born in Massachusetts and came to Hounsfield in 1830."

o. 1880 U.S. census, Jefferson County, New York, population schedule, Adams, E.D. 98, p. 5, dwelling/family 55, Margret Bosworth in Ambrose Bosworth household; image, *FamilySearch* (<https://www.familysearch.org> : accessed 18 Nov 2020); citing National Archives microfilm publication T9, roll 838. [Link](#)

p. New York Department of Health, Bureau of Vital Statistics, Certificate of Death, Monroe County, no. 37345, Margaret E. Bosworth, 30 Aug 1909; digital image, "Great Amount of Information on Daniel Arnold," PDF document in the files of Bruce Arnold, p. 39.

q. 1880 U.S. census, Jefferson County, New York, population schedule, Henderson, E.D. 119, p. 2, dwelling 12, family 14, Louisa Ivory in Theodore Ivory household; image, *FamilySearch* (<https://www.familysearch.org> : accessed 18 Nov 2020); citing National Archives microfilm publication T9, roll 839. [Link](#)

r. 1880 U.S. census, Jefferson County, New York, population schedule, Champion, E.D. 111, p. 24, dwelling 247, family 269, James K. Arnold, boarder in Celestine Fitzpatrick household; image, *FamilySearch* (<https://www.familysearch.org> : accessed 18 Nov 2020); citing National Archives microfilm publication T9, roll 838. [Link](#)

s. 1880 U.S. census, Jefferson County, New York, population schedule, Hounsfield, E.D. 125, p. 1, dwelling/family 8, Lucy Holden in Winfield Holden household; image, *FamilySearch* (<https://www.familysearch.org> : accessed 18 Nov 2020); citing National Archives microfilm publication T9, roll 839. [Link](#)

t. 1900 U.S. census, Jefferson County, New York, population schedule, Hounsfield, E.D. 21, sheet 13B, dwelling 250, family 352, Lucy Holden in Winfield Holden household; image, *FamilySearch* (<https://www.familysearch.org> : accessed 18 Nov 2020); citing National Archives microfilm publication T623, roll 1041. [Link](#)

u. New York Department of Health, Bureau of Vital Statistics, Certificate of Death, Jefferson County, no. 92437, Lucy Holden, 15 Jan 1905; digital image, "Great Amount of Information on Daniel Arnold," p. 55.

Although records don't agree on Daniel's birthplace, his residence from 1830 and forward is known. In 1830, Daniel resided in Redfield, Oswego County, New York.<sup>38</sup> His near neighbor was his wife Lydia's father, Titus Willey.<sup>39</sup> Oswego County was created in 1816 from Oneida County, which was formerly part of Herkimer County.<sup>40</sup> Many counties were created and many county boundaries changed in New York from 1785-1815.<sup>41</sup>

In 1840, Daniel resided in Hounsfield, Jefferson county, New York.<sup>42</sup> By 1860, Lydia was deceased and Daniel had moved to the town of Henderson, Jefferson County, in his son Wilson's household.<sup>43</sup>

---

<sup>38</sup> 1830 U.S. census, Oswego County, New York, population schedule, Redfield, p. 314, line 2, Daniel Arnold; image, *FamilySearch* (<https://www.familysearch.org/ark:/61903/3:1:33S7-9YB7-KHJ> : accessed 9 Nov 2020); citing National Archives microfilm publication M19, roll 115.

<sup>39</sup> 1830 U.S. census, Oswego County, New York, population schedule, Redfield, p. 314, line 1, Titus Willie; image, *FamilySearch* (<https://www.familysearch.org/ark:/61903/3:1:33S7-9YB7-KHJ> : accessed 9 Nov 2020); citing National Archives microfilm publication M19, roll 115.

<sup>40</sup> "Oswego County, New York," *Wikipedia* ([https://en.wikipedia.org/wiki/Oswego\\_County,\\_New\\_York](https://en.wikipedia.org/wiki/Oswego_County,_New_York) : last edited on 18 November 2020, at 17:28 UTC).

<sup>41</sup> "Interactive Map of New York County Formation History," 1806, *Map of Us* (<https://www.mapofus.org/newyork/> : accessed 19 Nov 2020).

<sup>42</sup> 1840 U.S. census, Jefferson County, New York, population schedule, Hounsfield, p. 243, line 29, Daniel Arnold; image, *FamilySearch* (<https://www.familysearch.org/ark:/61903/3:1:33S7-9YBW-TSJ> : accessed 13 Nov 2020); citing National Archives microfilm publication M704, roll 291.

<sup>43</sup> 1860 U.S. census, Henderson County, New York, population schedule, Henderson, p. 86-87, dwelling 710, family 721, Daniel Arnold in Wilson Arnold household; image, *FamilySearch* (<https://www.familysearch.org/ark:/61903/3:1:33S7-9BSD-SSKK> : accessed 13 Nov 2020); citing National Archives Microfilm publication M653, roll 762.



Sometime before 1865, he married his second wife, Almira, whom he lived with in Henderson in 1865.<sup>44</sup> He remained in Henderson until his death in 1881.<sup>45</sup>

## Locality Information

Saratoga County, the probable location of Daniel Arnold's birth, is located near the eastern border of New York near Vermont, New Hampshire, and Massachusetts. Saratoga County was organized in 1791 and at that time already had 17,000 inhabitants.<sup>46</sup> In 1806, when Daniel Arnold was born, Saratoga County bordered Washington County to the north and east, and Rensselaer counties to the southeast, Albany county to the south, and Montgomery county to the west, as shown in figure 4.

Lydia was born in Otsego County, also shown in Figure 4. In 1808, at the time of her birth, Otsego was one county west of Saratoga County – bordering Montgomery County. Otsego County, along with other counties in Central New York, experienced a large wave of emigration from the New England states after the Revolutionary War. It grew in population from 1,702 in 1790 to 51,372 in 1830.<sup>47</sup>

---

<sup>44</sup> 1865 New York state census, Jefferson County, Henderson, p. 35, dwelling 251, family 266, Daniel Arnold household; image, *FamilySearch* (<https://www.familysearch.org/ark:/61903/3:1:9392-9FSG-F3> : accessed 10 Nov 2020).

<sup>45</sup> *Find a Grave*, database and images (<https://www.findagrave.com/memorial/83032680/> : accessed 13 November 2020), memorial page for Daniel Arnold (6 Aug 1806–16 Jun 1881), Find a Grave Memorial no. 83032680, citing Smithville Cemetery, Smithville, Jefferson County, New York, USA ; Maintained by noelle nann fairbanks (contributor 46830790), headstone photo by Anne Cady (contributor 46985237).

<sup>46</sup> Nathaniel Barlett Sylvester, *History of Saratoga County, New York with Illustrations and Biographical Sketches of Some of its Prominent Men and Pioneers* (Philadelphia: Everts & Ensign, 1878) 77; image copy, *Google Books* ([https://www.google.com/books/edition/History\\_of\\_Saratoga\\_County\\_New\\_York/j8spAQAAMAAJ](https://www.google.com/books/edition/History_of_Saratoga_County_New_York/j8spAQAAMAAJ) : accessed 24 Nov 2020).

<sup>47</sup> "History of Otsego County," *Genealogy Trails* ([http://genealogytrails.com/ny/otsego/history\\_county.html](http://genealogytrails.com/ny/otsego/history_county.html) : accessed 24 Nov 2020); citing Otsego County New York Geographical and Historical, by Edwin F. Bacon, The Oneonta Herald, Publishers (1902).

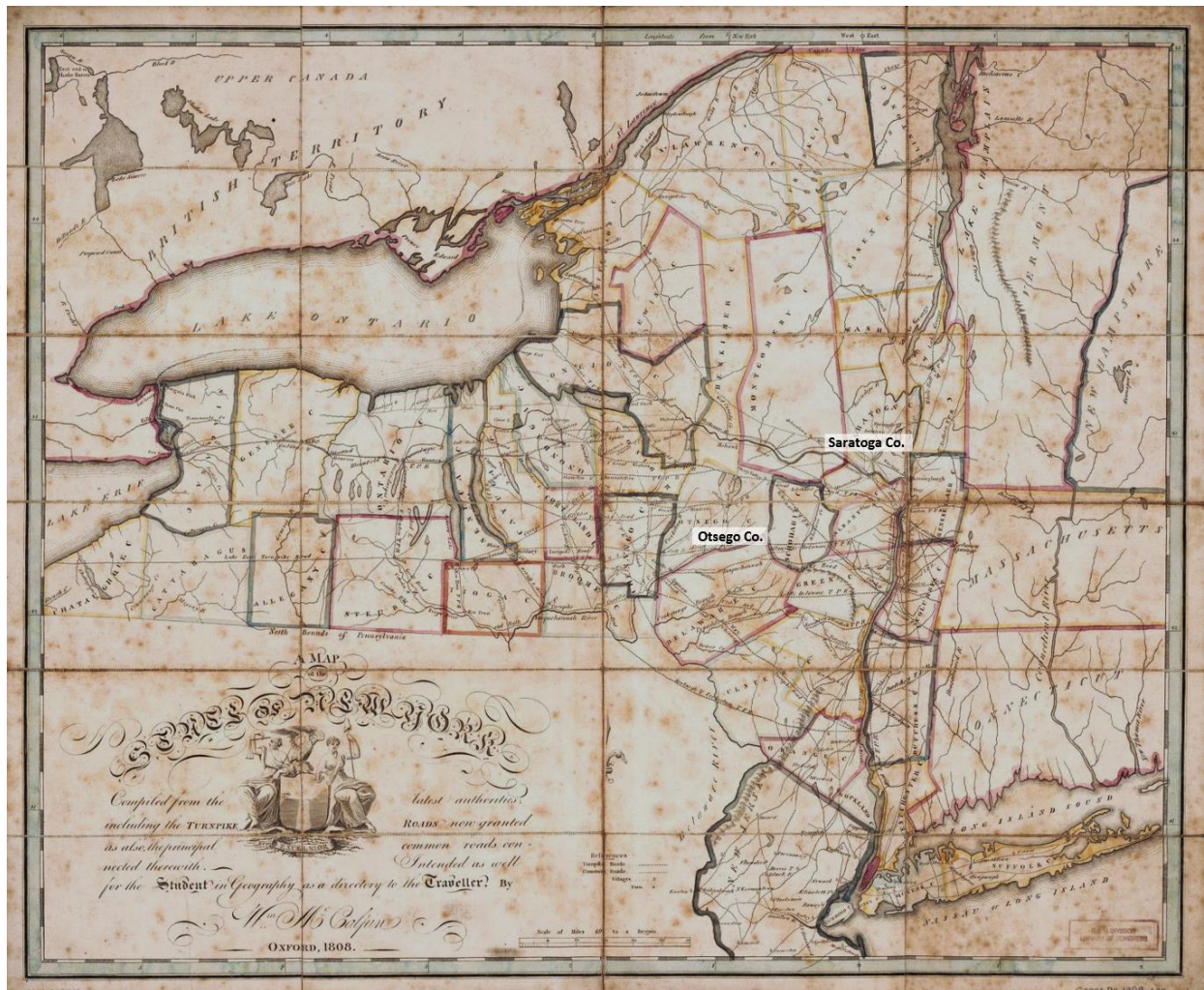

Figure 4 - Map of the State of New York, 1808, showing Daniel and Lydia's birthplaces in Saratoga and Otsego Counties<sup>48</sup>

Daniel's family may have left Saratoga County and resided for a while in Otsego County, where Daniel may have met Lydia. Many central New York county boundaries changed after 1800 and additional counties were created.<sup>49</sup> Jefferson County was created in 1805 and Oswego County was created in 1816.<sup>50</sup> By 1826, most counties boundaries were settled, as shown in Figure 5. Daniel resided in Oswego County by 1830.<sup>51</sup> He resided in Jefferson County by 1860.<sup>52</sup> These residences are highlighted in Figure 5.

<sup>48</sup> Wm. Mccalpin, *A map of the State of New York: compiled from the latest authorities: including the turnpike roads now granted, as also the principal common roads connected therewith: intended as well for the student in geography as a directory to the traveller* (Oxford New York: Wm. Mccalpin, 1808); image, *Library of Congress* (<https://www.loc.gov/item/2014585742/> : accessed 19 Nov 2020). Labels added.

<sup>49</sup> "Interactive Map of New York County Formation History," 1806, *Map of Us*.

<sup>50</sup> *Ibid.*, 1805 and 1816.

<sup>51</sup> 1830 U.S. census, Oswego Co., New York, pop. sch., Redfield, p. 314, line 2, Daniel Arnold.

<sup>52</sup> 1860 U.S. census, Henderson Co., New York, pop. sch., Henderson, p. 86-87, dwell. 710, fam. 721, Daniel Arnold in Wilson Arnold household.





Figure 5 - Map of New York, 1826, showing Daniel's residence in Oswego and Jefferson Counties, as well as the counties of Daniel and Lydia's birth – Saratoga and Otsego.<sup>53</sup>

## Findings in Traditional Records

Research was conducted into records of Daniel Arnold and his wife's family to find any clues leading to a family of origin. Possible candidates for Daniel Arnold's father were sought by searching records of the locations where Daniel lived and may have lived in his early years.

Daniel was probably living with his father and mother in 1820, when he was about 14 years old. The 1820 census should be searched for father candidates. Daniel must have met Lydia sometime after 1820 and before 1827 when their first son, Titus, was born. In 1820, Lydia was likely living with her father, Titus Willey, who resided in Exeter, Otsego County, New York.<sup>54</sup> His household included a female, age

<sup>53</sup> William Williams and S Stiles, *The Traveller's pocket map of New York: from the best authorities* (Utica, New York: W. Williams, 1826); image, *Library of Congress* (<https://www.loc.gov/item/8369424/> : accessed 19 Nov 2020). Labels added.

<sup>54</sup> 1820 U.S. census, Otsego County, New York, population schedule, Exeter, p. 170, line 5, Titus Willey; image, *FamilySearch* (<https://www.familysearch.org/ark:/61903/3:1:33S7-9YYK-RDB> : accessed 19 Nov 2020); citing National Archives publication M33, roll 74.

10-15, probably Lydia. Perhaps Daniel and Lydia met in Exeter, married, then migrated together with Lydia's father, Titus, to Oswego County, where they were neighbors in 1830.<sup>55</sup>

Only one Arnold family lived in Exeter, Otsego County in 1820 – Amasa Arnold.<sup>56</sup>

### Amasa Arnold in Census Records

Amasa Arnold's 1820 household had a man and woman over age 45, and eight people under age 25. Amasa's household included two males, age 10-15, and one of them could have been Daniel.

#### 1820 Household of Amasa Arnold in Exeter, Otsego County, New York

Males - Under 10:	2	Females - 10 thru 15:	1
Males - 10 thru 15:	2	Females - 16 thru 25:	2
Males - 16 thru 25:	1	Females - 45 and over :	1
Males - 45 and over:	1		

Amasa Arnold is a candidate for Daniel Arnold's father. He was over 45 in 1820, so born before 1775. In 1820, he was living in close proximity to Daniel's future wife's family, the Willeys. Proximity is often evidence of a familial relationship. Amasa had a household member of the correct age and gender to be Daniel. Daniel named his second son Amasa, perhaps after his father.<sup>57</sup> These clues provide indirect evidence that Amasa Arnold, living in Exeter in 1820, was the father of Daniel. More evidence should be gathered about Amasa Arnold to test this hypothesis, including census records, to establish his residence and household makeup, and land and probate records, to determine any heirs.

In 1810, "A Arnold" was living in Exeter.<sup>58</sup> This is probably the same man as Amasa Arnold of Exeter in 1820. The line before A Arnold was "D Arnold," a possible brother or father, over 45 years, born before 1765.<sup>59</sup> Future research could explore D Arnold further. A Arnold's household included a male and female age 26-44, the inferred parents, and eight inferred children, ages 25 and under. A Arnold was age 26-44 in 1810, so he was born 1766-1784.

#### 1810 Household of A Arnold in Exeter, Otsego County, New York

Males - Under 10:	2	Females - Under 10:	2
Males - 10 thru 15:	2	Females - 10 thru 15:	1
Males - 26 thru 44 :	1	Females - 16 thru 25:	1
		Females - 26 thru 44:	1

<sup>55</sup> 1830 U.S. census, Oswego Co., New York, pop. sch., Redfield, p. 314, line 2, Daniel Arnold.

<sup>56</sup> 1820 U.S. census, Otsego County, New York, population schedule, Exeter, p. 167, line 42, Amasa Arnold; image, *Ancestry* ([https://www.ancestry.com/imageviewer/collections/7734/images/4433301\\_00178](https://www.ancestry.com/imageviewer/collections/7734/images/4433301_00178) : accessed 19 Nov 2020); citing National Archives publication M33, roll 74.

<sup>57</sup> For Daniels children's names, see Jefferson Co., New York, Wills 20:229-232, Daniel Arnold, 24 June 1881.

<sup>58</sup> 1810 U.S. census, Otsego County, New York, Exeter, p. 20, line 14, A. Arnold; image, *Ancestry* ([https://www.ancestry.com/imageviewer/collections/7613/images/4433229\\_00075](https://www.ancestry.com/imageviewer/collections/7613/images/4433229_00075) : accessed 19 Nov 2020); citing National Archives publication M252, roll 34.

<sup>59</sup> *Ibid.*, line 13, D. Arnold.

In 1800, Amasa Arnold was living in Greenfield, Saratoga County, New York.<sup>60</sup> There were no other Amasa Arnolds enumerated in 1800.<sup>61</sup> This is the location that Daniel Arnold stated he was born, adding evidence to the hypothesis that Amasa Arnold was his father. Amasa was age 26-44 in 1800, born about 1756-1774.

#### 1800 Household of Amasa Arnold in Greenfield, Saratoga, New York

Males - Under 10:	2	Females - Under 10:	2
Males - 26 thru 44:	1	Females - 26 thru 44:	1

No Amasa Arnold was found on the 1790 census, except an Asa Amasa Arnold from Middlesex County, Connecticut.<sup>62</sup> Asa A. Arnold appeared in the 1800 census in the same locality, so this was almost certainly a different man.<sup>63</sup>

To determine when Amasa Arnold died, the 1830 and 1840 censuses were also searched. Amasa Arnold was found residing in Exeter in 1830.<sup>64</sup>

#### 1830 Household of Amasa Arnold in Exeter, Otsego County, New York

Males - 10 thru 14	1	Females - Under 5	1
Males - 50 thru 59	1	Females - 5 thru 9	1
		Females - 20 thru 29	1
		Females - 50 thru 59	1
		Females - 90 thru 99	1

Amasa Arnold's age was age 50-59 in 1830, born about 1771-1780. In 1840, no Amasa Arnold was found in the Exeter or anywhere in New York.<sup>65</sup> The 1840 census only included one man named Amasa Arnold

<sup>60</sup> 1800 U.S. census, Saratoga County, New York, Greenfield, p. 1134, line 9, Amasa Arnold; image, *Ancestry* ([https://www.ancestry.com/imageviewer/collections/7590/images/4440844\\_00109](https://www.ancestry.com/imageviewer/collections/7590/images/4440844_00109) : accessed 19 Nov 2020); citing National Archives publication M32, roll 27.

<sup>61</sup> "1800 United States Federal Census," search results for Amasa Arnold, *Ancestry* (<https://www.ancestry.com/search/collections/7590/> : accessed 21 Nov 2020).

<sup>62</sup> 1790 U.S. census, Middlesex County, Connecticut, Middleton, p. 421, col. 1, line 46, Asa Amasa Arnold; image, *Ancestry* ([https://www.ancestry.com/imageviewer/collections/5058/images/4440867\\_00370](https://www.ancestry.com/imageviewer/collections/5058/images/4440867_00370) : accessed 19 Nov 2020); citing National Archives publication M637, roll 1.

<sup>63</sup> 1800 U.S. census, Middlesex County, Connecticut, Middleton, p. 447, Asa A. Arnold; image, *Ancestry* ([https://www.ancestry.com/imageviewer/collections/7590/images/4440901\\_00050](https://www.ancestry.com/imageviewer/collections/7590/images/4440901_00050) : accessed 19 Nov 2020); citing National Archives microfilm publication M32.

<sup>64</sup> 1830 U.S. census, Otsego County, New York, population schedule, Exeter, p. 29, line 6, Amasa Arnold; image, *Ancestry* ([https://www.ancestry.com/imageviewer/collections/8058/images/4410714\\_00057](https://www.ancestry.com/imageviewer/collections/8058/images/4410714_00057) : accessed 19 Nov 2020); citing National Archives publication M19, roll 102.

<sup>65</sup> "1840 United States Federal Census," search results for Amasa Arnold, place: New York, *Ancestry* (<https://www.ancestry.com/search/collections/8057/> : accessed 21 Nov 2020).

and he lived in Adams, Berkshire, Massachusetts.<sup>66</sup> This Amasa Arnold also resided in Adams in 1830, when Amasa Arnold of New York was living in Exeter; they were two separate men.<sup>67</sup>

Amasa Arnold of Exeter likely died between 1830 and 1840, since he disappeared from census records before 1840. Census records also reveal birth year ranges for Amasa shown in table 4.

Census	Age	Birth Year Range
1800 census in Saratoga Co. <sup>a</sup>	45+	before 1775
1810 census in Otsego Co. <sup>b</sup>	26-44	1766-1784
1820 census in Otsego Co. <sup>c</sup>	26-44	1756-1774
1830 census in Otsego Co. <sup>d</sup>	50-59	1771-1780

a. 1800 U.S. census, Saratoga County, New York, Greenfield, p. 1134, line 9, Amasa Arnold; image, *Ancestry* ([https://www.ancestry.com/imageviewer/collections/7590/images/4440844\\_00109](https://www.ancestry.com/imageviewer/collections/7590/images/4440844_00109) : accessed 19 Nov 2020); citing National Archives publication M32, roll 27.

b. 1810 U.S. census, Otsego County, New York, Exeter, p. 20, line 14, A. Arnold; image, *Ancestry* ([https://www.ancestry.com/imageviewer/collections/7613/images/4433229\\_00075](https://www.ancestry.com/imageviewer/collections/7613/images/4433229_00075) : accessed 19 Nov 2020); citing National Archives publication M252, roll 34.

c. 1820 U.S. census, Otsego County, New York, population schedule, Exeter, p. 170, line 5, Titus Willey; image, *FamilySearch* (<https://www.familysearch.org/ark:/61903/3:1:33S7-9YYK-RDB> : accessed 19 Nov 2020); citing National Archives publication M33, roll 74.

d. 1830 U.S. census, Otsego County, New York, population schedule, Exeter, p. 29, line 6, Amasa Arnold; image, *Ancestry* ([https://www.ancestry.com/imageviewer/collections/8058/images/4410714\\_00057](https://www.ancestry.com/imageviewer/collections/8058/images/4410714_00057) : accessed 19 Nov 2020); citing National Archives publication M19, roll 102.

Amasa Arnold's birth year range can be narrowed to 1771-1774 by combining the ranges above. His place of birth was not revealed in the census records. If he is the father of Daniel Arnold, perhaps he was born in Massachusetts as reported on the 1880 census as Daniel's father's birthplace.<sup>68</sup> Further research could be done in Massachusetts town birth records for Amasa Arnold.

## Probate & Land Records

Probate and deed records might reveal more about Amasa Arnold. Probate records were searched, and no will or administration was found for Amasa Arnold in Otsego County from 1792-1887.<sup>69</sup> Future

<sup>66</sup> 1840 U.S. census, Berkshire County, Massachusetts, population schedule, Adams, p. 86, line 19, Amasa Arnold, image, *Ancestry* ([https://www.ancestry.com/imageviewer/collections/8057/images/4410768\\_00754](https://www.ancestry.com/imageviewer/collections/8057/images/4410768_00754) : accessed 20 Nov 2020); citing National Archives publication M704, roll 175.

<sup>67</sup> 1830 U.S. census, Berkshire County, Massachusetts, population schedule, Adams, p. 475, line 9, Amasa Arnold; image, *Ancestry* ([https://www.ancestry.com/imageviewer/collections/8058/images/4411241\\_00954](https://www.ancestry.com/imageviewer/collections/8058/images/4411241_00954) : accessed 20 Nov 2020); citing National Archives publication M19, roll 62.

<sup>68</sup> 1880 U.S. census, Jefferson Co., New York, pop. sch., Henderson, E.D. 119, p. 4, dwell. 29, fam. 32, Daniel Arnold household.

<sup>69</sup> Otsego County, New York, Wills and proceedings index, negative search for Amasa Arnold, 1792-1887; images, *FamilySearch* (<https://www.familysearch.org/ark:/61903/3:1:33SQ-GYC5-4F5> : accessed 23 Nov 2020). See also Otsego County, New York, Letters Testamentary and of Administration index, negative search for Amasa Arnold, 1816-1890; images, *FamilySearch* (<https://www.familysearch.org/ark:/61903/3:1:33SQ-GYC2-R1V> : accessed 23 Nov 2020). See also Otsego County, New York, Index of proceedings in administration of intestates estates, negative search for Amasa Arnold; images, *FamilySearch* (<https://www.familysearch.org/ark:/61903/3:1:33SQ-GYC2-RY9> : accessed 23 Nov 2020). See also "New York, U.S., Wills and Probate Records, 1659-1999," negative search for Amasa Arnold, *Ancestry* (<https://www.ancestry.com/search/collections/8800> : accessed 24 Nov 2020).



research could be done in Otsego County Surrogate Court records, including real estate proceedings and miscellaneous records, to locate information about Amasa Arnold.

Deed records for Otsego County were searched but no entry was found in the grantee or grantor index for Amasa Arnold from 1790-1840.<sup>70</sup> Future research could include a search of the deeds for Amasa's neighbors on the census and may reveal when he arrived in Exeter. Additional research could be done in New York land patents.

There was an entry in the Otsego County grantor index for Amos Arnold in 1835, which was checked because of the name similarity. The deed revealed that it was for Amos Arnold, not Amasa. Amos Arnold, resident of Exeter, with his wife Lorena, sold land to Richard Washburn in 1834.<sup>71</sup> The parcel of land was a part of the Schuyler patent, where Amos resided in 1834, part of lot 155. The Schuyler patent was an Indian deed granted to David Schuyler and others in 1754 in what is now Otsego, New York.<sup>72</sup> No deed was found in which Amos Arnold as the recipient of this land.<sup>73</sup> Some deeds were not recorded in the county clerk's office, but after 1830, the state required it. Future research could search New York Secretary of State deeds where some early deeds were recorded.<sup>74</sup>

Because Amos Arnold lived in Exeter, the same town as Amasa Arnold, additional research was done to learn about him in census, cemetery, and probate records.

### Amos Arnold's Family

Amos Arnold was the head of his household in Exeter in 1830, enumerated just a few households before Amasa Arnold on the census.<sup>75</sup>

#### 1830 Household of Amos Arnold in Exeter, Otsego County, New York

Males - 30 thru 39	1	Females - 20 thru 29	1
--------------------	---	----------------------	---

Amos Arnold was age 30-39 in 1830, so he was born about 1791-1800, young enough to be the son of Amasa Arnold.

<sup>70</sup> Otsego County, New York, Grantor and Grantee Deed Index, 1790-1840, negative search for Amasa Arnold; images, *FamilySearch* (<https://www.familysearch.org/search/catalog/242628> : accessed 23 Nov 2020).

<sup>71</sup> Otsego County, New York, Deeds 53:147-148, 20 November 1835, Amos Arnold – Richard Washburn; image, *FamilySearch* (<https://www.familysearch.org/ark:/61903/3:1:3QS7-L9WT-9275> : accessed 20 Nov 2020).

<sup>72</sup> "Survey map of Schuylers Patent, Otsego County, New York," manuscript description, *ArchiveGrid* (<https://researchworks.oclc.org/archivegrid/record.php?id=145408044> : accessed 24 Nov 2020).

<sup>73</sup> Otsego County, New York, Index of Deeds 1:49, negative search for Amos Arnold before 1834; image, *FamilySearch* (<https://www.familysearch.org/ark:/61903/3:1:3QS7-L9W2-5Y85> : accessed 24 Nov 2020).

<sup>74</sup> "New York Land and Property," *FamilySearch Wiki* ([https://www.familysearch.org/wiki/en/New\\_York\\_Land\\_and\\_Property](https://www.familysearch.org/wiki/en/New_York_Land_and_Property) : last edited on 22 June 2020, at 15:16).

<sup>75</sup> 1830 U.S. census, Otsego County, New York, population schedule, Exeter, p. 28, line 26, Amos Arnold; image, *Ancestry* ([https://www.ancestry.com/imageviewer/collections/8058/images/4410714\\_00055](https://www.ancestry.com/imageviewer/collections/8058/images/4410714_00055) : accessed 19 Nov 2020); citing National Archives publication M19, roll 102.

Otsego County land records revealed that Amos Arnold purchased land in Unadilla, Otsego County, on 13 May 1836.<sup>76</sup> The 1840 census shows that Amos and Lorena may have hosted another couple, age 20-29, in their home, but no children under age 20.<sup>77</sup>

#### 1840 Household of Amos Arnold in Unadilla, Otsego County, New York

Males - 20 thru 29:	1	Females - 20 thru 29:	1
Males - 40 thru 49:	1	Females - 30 thru 39:	1

Cemetery records were searched for Arnolds in Otsego County to discover more about Amos Arnold. Amos Arnold's wife, Lorena Arnold, died in 1844 and was buried in Spencer Cemetery, Unadilla, Otsego County.<sup>78</sup> Her headstone mentioned her husband, Amos Arnold:

Lorena  
Wife of  
Amos Arnold  
Died Jul 12, 1844  
Age 44 years 6 months

If Lorena was 44 years and 6 months on July 12, 1844, Lorena's calculated birthdate is January 12, 1800.

By 1850, Amos Arnold resided with a new presumed wife, Emily, in Cato, Cayuga County.<sup>79</sup> He was 45 years old, born about 1805. He probably decided to move after his wife Lorena died in July of 1812. He sold his land in Unadilla in November of 1844.<sup>80</sup> Future research could examine deeds in Cayuga County.

1850 Household of Amos Arnold in Cato, Cayuga County, New York			
Name	Age	Occupation	Birthplace
Amos Arnold	45	Farmer	New York
Emily Arnold	35		New York

<sup>76</sup> Otsego County, New York, Deeds 75:332-334, 13 May 1836, Richard Morris – Amos Arnold; image, *FamilySearch* (<https://www.familysearch.org/ark:/61903/3:1:3QSQ-G9WT-HTWK> : accessed 21 Nov 2020).

<sup>77</sup> 1840 U.S. census, Otsego County, New York, population schedule, Unadilla, p. 218, line 17, Amos Arnold; image, *Ancestry* ([https://www.ancestry.com/imageviewer/collections/8057/images/4409546\\_00441](https://www.ancestry.com/imageviewer/collections/8057/images/4409546_00441) : accessed 21 Nov 2020); citing National Archives publication M704, roll 328.

<sup>78</sup> *Find a Grave*, database and images (<https://www.findagrave.com/memorial/92743525/lorena-arnold> : accessed 20 November 2020), memorial page for Lorena Arnold (12 Jan 1800–12 Jul 1844), Find a Grave Memorial no. 92743525, citing Spencer Cemetery, Unadilla, Otsego County, New York, USA ; Maintained by Kurt Riegel (contributor 47698588), headstone photo by Tina Horton Utter (contributor 46532926).

<sup>79</sup> 1850 U.S. census, Cayuga County, New York, population schedule, Cato, p. 38, dwelling 266, family 283, Amos Arnold; image, *Ancestry* (<https://www.ancestry.com/imageviewer/collections/8054/images/4196769-00044> : accessed 21 Nov 2020); citing National Archives publication M432, roll 481.

<sup>80</sup> Otsego County, New York, Deeds 77:22, Amos Arnold - Albert Stanard, 22 Nov 1844; image, *FamilySearch* (<https://www.familysearch.org/ark:/61903/3:1:3Q57-89WT-SDTY> : accessed 21 Nov 2020).



In 1855, Amos Arnold lived with his wife, Emily in Cato, Cayuga County, and was age 57, born about 1798.<sup>81</sup> The discrepancy in age between the 1850 and 1855 census can be explained by whoever reported Amos's age having an imperfect memory (perhaps his wife). The census reports that Amos was born in Saratoga County. If Amos Arnold was born in Saratoga County in 1798, he is a good candidate to be the son of Amasa Arnold and a brother to Daniel Arnold.

<b>1855 Household of Amos Arnold in Cato, Cayuga County, New York</b>				
<i>Name</i>	<i>Age</i>	<i>Relation</i>	<i>Occupation</i>	<i>Birthplace</i>
Amos Arnold	57	Head	Farmer	Saratoga
Emily Arnold	41	Wife		Cayuga
Pena Myres	74	Hired		Massachusetts

Amos Arnold resided in Cato, Cayuga County in 1860.<sup>82</sup> His age was 62 years, born about 1798, agreeing with the 1855 age and birthdate. It appears that a woman named Mires is still living in their home, but her name and age appear to be in error. She is most likely the same woman who appeared as Amos and Emily Arnold's hired help in 1855.

<b>1860 Household of Amos Arnold in Cato, Cayuga County, New York</b>			
<i>Name</i>	<i>Age</i>	<i>Occupation</i>	<i>Birthplace</i>
Amos Arnold	62	Farmer	New York
Emily J Arnold	41	W	New York
Emily J Mires	2		New York

Amos died 6 November 1866 and was buried in Lamphere Cemetery in Brutus, Cayuga County, New York. His age at death was 68 years, born about 1798.<sup>83</sup> Probate records were searched to determine if Amos Arnold's will included children or relatives. His will, written in 1865, proved in 1866, included both real and personal property. A full transcription of the will is in Attachment 1. Amos designated his wife Emily J. Arnold as executrix and heir.<sup>84</sup> She presented the will to the surrogate court and in her deposition stated she did not know all the names of her deceased husband's heirs-at-law, except:

- [--?--] Arnold
- Charles Arnold
- Clara Mason
- Elizabeth Adams

<sup>81</sup> 1855 New York state census, Cayuga county, population schedule, Cato, p. 14, dwelling 114, family 121, Amos Arnold household; image, *Ancestry* ([https://www.ancestry.com/imageviewer/collections/7181/images/005207172\\_00466](https://www.ancestry.com/imageviewer/collections/7181/images/005207172_00466) : accessed 21 Nov 2020)

<sup>82</sup> 1860 U.S. census, Cayuga County, population schedule, Cato, p. 37, dwelling 285, family 298, Amos Arnold; image, *Ancestry* ([https://www.ancestry.com/imageviewer/collections/7667/images/4235212\\_00355](https://www.ancestry.com/imageviewer/collections/7667/images/4235212_00355) : accessed 21 Nov 2020); citing National Archives publication M653, roll 728.

<sup>83</sup> *Find a Grave*, database and images (<https://www.findagrave.com/memorial/91353057/amos-arnold> : accessed 21 November 2020), memorial page for Amos Arnold (1798–6 Nov 1866), Find a Grave Memorial no. 91353057, citing Lamphere Cemetery, Brutus, Cayuga County, New York, USA ; Maintained by DMAC (contributor 47501381), headstone photo by Anne Cady (contributor 46985237).

<sup>84</sup> Cayuga County, New York, Wills Q:189-191, Amos Arnold, 1866; image, *FamilySearch* (<https://www.familysearch.org/ark:/61903/3:1:33S7-9YC6-LS3> : accessed 21 Nov 2020).

Emily's deposition included the following statement: "...your petitioner does not know & cannot after diligent enquiry ascertain the ages or places of residence of any of the foregoing named persons, but supposes that they reside somewhere in the states of Michigan & Wisconsin."<sup>85</sup>

In New York, when a will was presented to the Surrogate Court relating to both real and personal estate, the surrogate was responsible to ascertain "the names and places of residence of the heirs, widow and next of kin of the testator, or that upon diligent inquiry, the same cannot be ascertained."<sup>86</sup> Those heirs and next of kin were then cited to appear at the probate hearing; they were given a chance to hear the will and contest it.<sup>87</sup>

In census records, Amos Arnold appeared to have no children. It is likely that the heirs and next of kin listed in his will were relatives other than his own children. New York law provided that whatever personal property was not bequeathed in the will of the deceased was distributed to the widow, children, or next of kin of the deceased. If there were no children, the widow and the next of kin (descendant, parent, brother or sister, or niece or nephew) was entitled to the surplus remaining after payment of debts and legacies.<sup>88</sup>

Amos Arnold was probably the son of Amasa Arnold, and the next-of-kin in his probate proceedings were probably siblings. To determine if Amos was the son of Amasa Arnold, future research could examine the origin of his land in Exeter, sold to Richard Washburn in 1834.<sup>89</sup> If Amasa Arnold was the original owner of that land, it could indicate a familial relationship between them.

Two of the probable siblings of Amos from his probate record were found in the DNA results as candidates for siblings of Daniel Arnold as well: Clara Mason and Charles Arnold. Future research could focus on finding Elizabeth (Arnold) Adams in New York, Wisconsin, or Michigan.

## Autosomal DNA Results

Autosomal DNA matches for TT1 and TT2 were examined. Two possible siblings of Daniel Arnold, listed in Amos Arnold's probate record, were found: Clarissa (Arnold) Mason, and Charles Arnold. Another possible Arnold relative was located – David Morise Arnold.

---

<sup>85</sup> Ibid.

<sup>86</sup> *Laws of the State of New York, Passed at the Sixtieth Session of the Legislature, Begun and Held at the city of Albany, the Third Day of January, 1837* (Albany: E. Croswell, 1837) 525; image, Google Books ([https://www.google.com/books/edition/Laws\\_of\\_the\\_State\\_of\\_New\\_York\\_Passed\\_at/MJoDAAAQAAJ](https://www.google.com/books/edition/Laws_of_the_State_of_New_York_Passed_at/MJoDAAAQAAJ)) : accessed 21 Nov 2020).

<sup>87</sup> Ibid., 525.

<sup>88</sup> George Bliss, *New York Code Of Civil Procedure Chapters 14 To 22, As Enacted In 1880, With Explanatory Notes Showing The Changes Introduced Thereby, Together With The Statutory Provisions On The Same Subjects Still Remaining In Force, With Notes Of Judicial Decisions On Pleading, Practice And Evidence*, Vol. II (New York: Baker, Voorhis, 1880) 725; image, Google Books ([https://www.google.com/books/edition/The\\_New\\_York\\_Code\\_of\\_Civil\\_Procedure/\\_WdCAQAAMAAJ](https://www.google.com/books/edition/The_New_York_Code_of_Civil_Procedure/_WdCAQAAMAAJ)) : accessed 24 Nov 2020).

<sup>89</sup> Otsego Co., New York, Deeds 53:147-148.

## Clarissa Arnold

C1, a DNA match to both TT1 and TT2, descends from Clarissa Arnold, born 1808 in New York, wife of Nehemiah Mason. Amounts of shared DNA are shown in table 5.

C1 was found in TT2's network graph in cluster 0, one of clusters connected to cluster 16 with known Arnold descendants. Future research could examine other matches in cluster 0 to see if they also descend from Clarissa Arnold.

Table 5 - DNA Match with C1			
Matching Individuals	Hypothesized Relationship	Shared cM	Shared cM Prediction for Relationship <sup>a</sup>
C1 and TT2	4th cousins	57 cM	0-139 cM (average 35 cM)
C1 and TT1	4th cousins once removed	12 cM	0-126 cM (average 28 cM)

a. Bettinger and Perl, "The Shared CM Project 4.0 tool v4," *DNA Painter*.

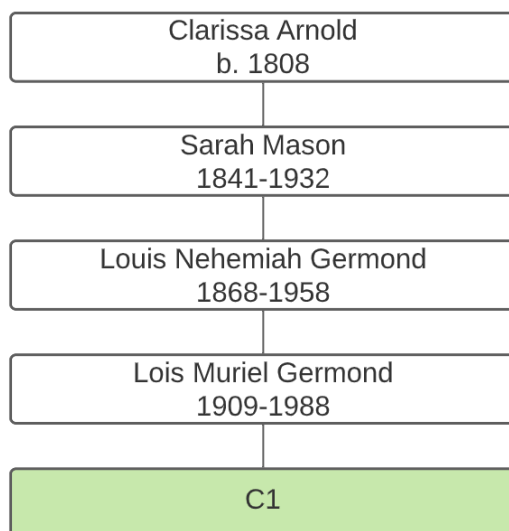

Figure 6 – DNA Match C1's line of descent from Clarissa Arnold

C1 has a family tree attached to her DNA results. Figure 6 shows her descent from Clarissa Arnold.<sup>90</sup> Future research can examine the parent-child links in C1's tree to determine their accuracy.

Clarissa Arnold could be a sibling to Daniel Arnold and could be the same woman named "Clara Mason" in Amos Arnold's 1866 probate record.<sup>91</sup> In the 1855 census, Clarissa Mason's birthplace was reportedly

<sup>90</sup> "Germond Family Tree," created by user PJohnston34, "Public Member Trees," database, *Ancestry* (<https://www.ancestry.com/family-tree/tree/43533507/family/pedigree> : accessed 23 Nov 2020).

<sup>91</sup> Cayuga County, New York, Wills Q:189-191, Amos Arnold, 1866; image, *FamilySearch* (<https://www.familysearch.org/ark:/61903/3:1:33S7-9YC6-LS3> : accessed 21 Nov 2020).

Otsego County, New York.<sup>92</sup> Otsego County is the same place that both Amasa Arnold and Amos Arnold resided in 1830.<sup>93</sup> Nehemiah and Clarissa appear to have married by 1830, when Nehemiah Mason Jr. headed a household in New Hartford, Oneida County, New York.<sup>94</sup> Clarissa (Arnold) Mason died in Flint, Genesee County, Michigan on 16 October 1885. Her death record states she was 77 years old, 5 months, and 8 days when she died and was born in New York, the daughter of Amos Arnold and Chloe Arnold of New York.<sup>95</sup> The Amos Arnold who died in 1865 could not have been Clarissa's father, because he was born 1798 – too young to father a child in 1808.<sup>96</sup>

"Amos and Chloe Arnold" could be *Amasa* and Chloe Arnold. Perhaps the informant on Clarissa's death record confused the name Amasa with Amos. Clarissa and Nehemiah named one of her sons Amasa, possibly after her father.<sup>97</sup> A marriage record for Amasa Arnold and Chloe Woodward in Charlton, Worcester County, Massachusetts is a close match to Clarissa's parents. The Charlton town register of marriages states, "August 11<sup>th</sup> 1793 Amasa Arnold and Chloe Woodward both of Charlton."<sup>98</sup> The marriage date of 1793 fits with the 1800 household of Amasa Arnold in Saratoga County, New York; the only children in the household were under age 10.<sup>99</sup>

Future research could search in Massachusetts town records for Amasa Arnold and Chloe Woodward birth records. The *FamilySearch Family Tree* includes parents for Chloe: Joshua Woodward and Sarah

---

<sup>92</sup> 1855 New York census, Oneida County, population schedule, Paris, E.D. 1, p. 22, dwelling 178, family 197, Clarissa Mason in Nehemiah Mason household; image, *FamilySearch* (<https://www.familysearch.org/ark:/61903/3:1:33SQ-GB53-CFB> : accessed 19 Nov 2020).

<sup>93</sup> 1830 U.S. census, Otsego County, New York, population schedule, Exeter, p. 29, line 6, Amasa Arnold; image, *Ancestry* ([https://www.ancestry.com/imageviewer/collections/8058/images/4410714\\_00057](https://www.ancestry.com/imageviewer/collections/8058/images/4410714_00057) : accessed 19 Nov 2020); citing National Archives publication M19, roll 102. For Amos, see 1830 U.S. census, Otsego County, New York, population schedule, Exeter, p. 28, line 26, Amos Arnold; image, *Ancestry* ([https://www.ancestry.com/imageviewer/collections/8058/images/4410714\\_00055](https://www.ancestry.com/imageviewer/collections/8058/images/4410714_00055) : accessed 19 Nov 2020); citing National Archives publication M19, roll 102.

<sup>94</sup> 1830 U.S. census, Oneida County, New York, population schedule, New Hartford, p. 56, line 2, Nehemiah Mason Jr; image, *Ancestry* (<https://www.familysearch.org/ark:/61903/3:1:33SQ-GYTY-NX4> : accessed 22 Nov 2020).

<sup>95</sup> "Michigan, U.S., Death Records, 1867-1952," Clara Mason, 18 October 1885, Genesee County; image, *Ancestry* ([https://www.ancestry.com/imageviewer/collections/60872/images/44471\\_355338-00636](https://www.ancestry.com/imageviewer/collections/60872/images/44471_355338-00636) : accessed 22 Nov 2020); citing Michigan Dept. of Health, Division for Vital Records and Health Statistics, Lansing, Michigan.

<sup>96</sup> *Find a Grave*, database and images (<https://www.findagrave.com/memorial/91353057/amos-arnold> : accessed 21 November 2020), memorial page for Amos Arnold (1798–6 Nov 1866), Find a Grave Memorial no. 91353057, citing Lamphere Cemetery, Brutus, Cayuga County, New York, USA ; Maintained by DMAC (contributor 47501381), headstone photo by Anne Cady (contributor 46985237).

<sup>97</sup> 1855 New York census, Oneida County, population schedule, Paris, E.D. 1, p. 22, dwelling 178, family 197, Amasa Mason in Nehemiah Mason household; image, *FamilySearch* (<https://www.familysearch.org/ark:/61903/3:1:33SQ-GB53-CFB> : accessed 19 Nov 2020). See also 1850 U.S. census, Oneida County, New York, population schedule, Paris, p. 386, dwelling 1233, family 1267, Amasa Mason in Nehemiah Mason household; image, *FamilySearch* (<https://www.familysearch.org/ark:/61903/3:1:S3HY-6WJ9-NN5> : accessed 23 Nov 2020); citing National Archives microfilm publication M432, roll 562.

<sup>98</sup> "Massachusetts, U.S., Town and Vital Records, 1620-1988," marriage, Charlton, Worcester County, Chloe Woodward and Amasa Arnold, 11 Aug 1793; image, *Ancestry* (<https://www.ancestry.com/discoveryui-content/view/15319655:2495> : accessed 23 Nov 2020).

<sup>99</sup> 1800 U.S. census, Saratoga Co., New York, Greenfield, p. 1134, line 9, Amasa Arnold.

Clemens.<sup>100</sup> Future research could examine the parents and siblings of Chloe and research their descendants to see if any atDNA matches can be located in the *AncestryDNA* database.

## Charles Arnold

Two of TT2's DNA matches descend from Charles Arnold, born 1807 in New York, a possible sibling of Daniel Arnold. Table 6 shows the amount of shared DNA and the predicted amount of shared DNA based on the hypothesized relationship. The matches are shared matches with each other indicating they all may have a common ancestor with TT2.

Matching Individuals	Hypothesized Relationship	Shared cM	Shared cM Prediction for Relationship <sup>a</sup>
H1 and TT2	3 <sup>rd</sup> cousins twice removed	33 cM	0-166 cM (average 36 cM)
H2 and TT2	3 <sup>rd</sup> cousins three times removed	10 cM	0-98 cM (average 27 cM)

a. Bettinger and Perl, "The Shared CM Project 4.0 tool v4," *DNA Painter*.

Previous correspondence with H1 found that he descends from Charles Arnold as shown in figure 7 below. H2 has a tree attached to their results showing descent from Charles Arnold, also shown in figure 7.<sup>101</sup> Future research could examine the accuracy of the parent-child links in her tree. Charles Arnold seems to have named one of his sons George Amos Arnold, according to H2's family tree, possibly indicating a naming pattern since Daniel Arnold named a son Amos George Arnold.

H1 was located in TT2's network graph in cluster 12. Cluster 12 is spread out and seems to have clusters within itself. Cluster 12 is connected to cluster 16 with known Arnold descendants. Cluster 12 is also connected to cluster 0, though it is difficult to see on the graph because the connecting lines go through the large, dense green cluster (16). See Figure 8 for a closeup view of the connection. Further research could be done to determine the common ancestors of group 12 to see if that cluster contains additional descendants of Charles Arnold.

<sup>100</sup> Joshua Woodward, ID LH28-9DD, "Family Tree," *FamilySearch* (<https://www.familysearch.org/tree/person/details/LH28-9DD>) : accessed 23 Nov 2020).

<sup>101</sup> "Ripley Family Tree," created by user Charlotte542013, "Public Member Trees," database, *Ancestry* (<https://www.ancestry.com/family-tree/tree/83747969/family/pedigree?cfpid=48487057528>) : accessed 23 Nov 2020).

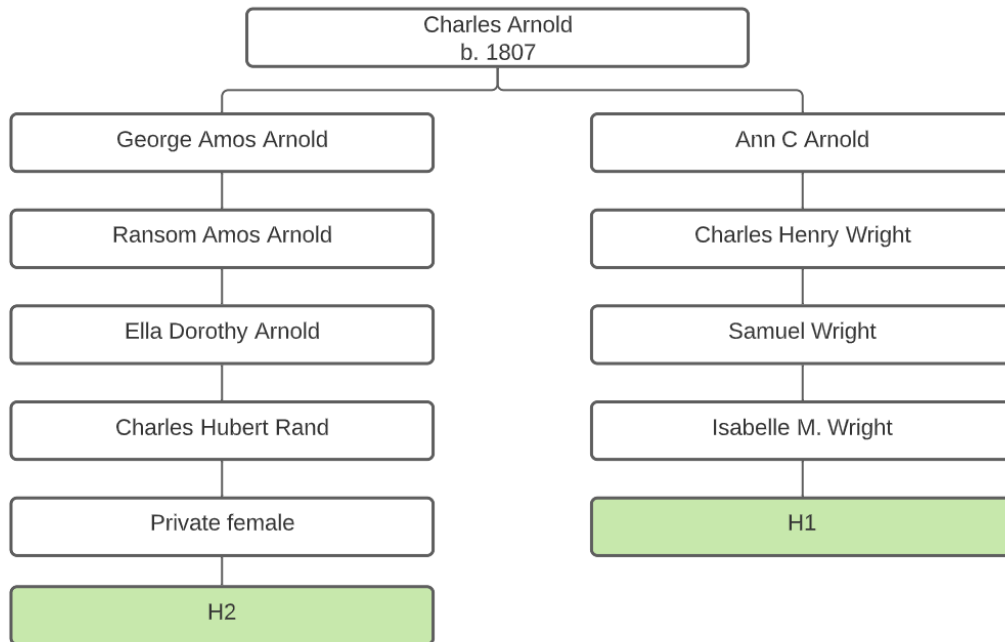

Figure 7: Charles Arnold descendants whose DNA matches TT2

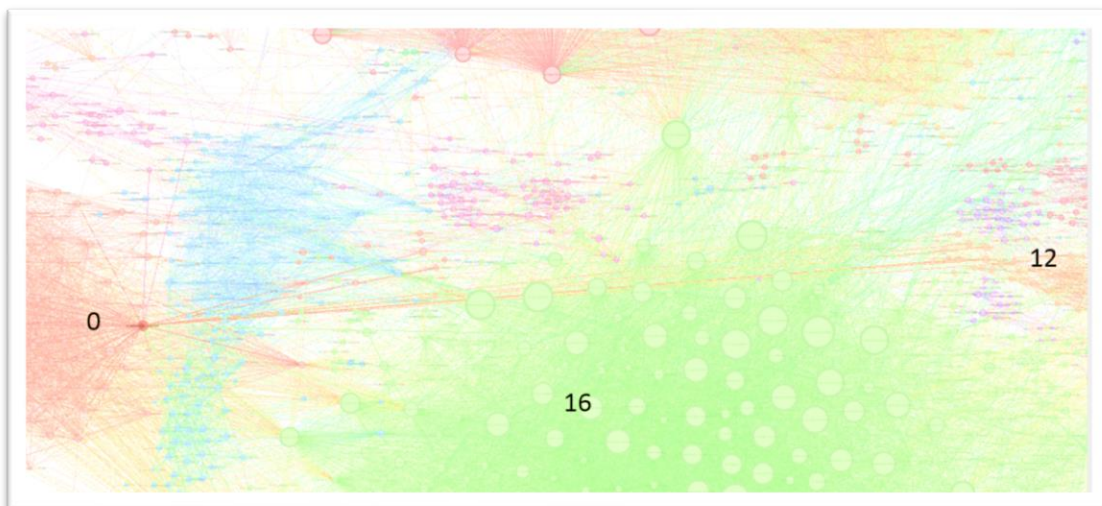

Figure 8 – Closeup of TT2’s network graph showing connection between cluster 0 and 12<sup>102</sup>

<sup>102</sup> Nicole Dyer, TT2’s AncestryDNA Network Graph, 15-260 cM.



Charles Arnold was found living in Exeter, Otsego County, beginning in 1830.<sup>103</sup> Only three Arnold men resided in Exeter in 1830 – Amasa, Amos, and Charles – providing evidence that they were probably related.<sup>104</sup> In 1830, Charles was age 20-29, born about 1800-1810; young enough to be a son of Amasa.

#### 1830 Household of Charles Arnold in Exeter, Otsego, New York

Males - Under 51		Females - Under 5	1
Males - 20 thru 29	1	Females - 20 thru 29	1

In 1840, Charles Arnold resided in Unadilla, Otsego County, New York.<sup>105</sup> His household included more children than in 1830:

#### 1840 Household of Charles Arnold in Unadilla, Otsego, New York

Males - 10 thru 14	1	Females - Under 5	1
Males - 30 thru 39	1	Females - 5 thru 9	1
		Females - 10 thru 14	1
		Females - 30 thru 39	1

Charles Arnold and his inferred wife, Almira, lived in Unadilla, Otsego, New York in 1850.<sup>106</sup> Charles was 43, born about 1807, and Almira was 44, born about 1806. They had five inferred children living with them: Caroline, age 23, Warren, 21, Ann C., 19, Emily, 12, and Amos, 7. In the 1855 census, Charles Arnold's age was reportedly 43, making him born about 1812, and Almira was age 49, born 1806. Charles' birthplace was Otsego County.<sup>107</sup>

If Charles was born about 1807-1812 in Otsego County, he could be a son of Amasa Arnold and a sibling to Amos Arnold. Charles Arnold was listed as an heir-at-law to his hypothesized brother, Amos Arnold, in his 1866 probate proceedings.<sup>108</sup> These two pieces of evidence combine to provide evidence that Charles was probably a son of Amasa Arnold and brother of Amos Arnold. Future research could find census records for Charles Arnold after 1855, land records in Otsego County, New York, cemetery

<sup>103</sup> 1830 U.S. census, Otsego County, New York, population schedule, Exeter, p. 26, line 23, Charles Arnold; image, *Ancestry* ([https://www.ancestry.com/imageviewer/collections/8058/images/4410714\\_00051](https://www.ancestry.com/imageviewer/collections/8058/images/4410714_00051) : accessed 24 Nov 2020); citing National Archives microfilm publication M19, roll 102.

<sup>104</sup> "1830 United States Federal Census," search results for Arnold in Exeter, Otsego, New York, *Ancestry* ([https://www.ancestry.com/search/collections/8058/?name=arnold&count=50&residence=exeter-otsego&residence\\_x=1-0](https://www.ancestry.com/search/collections/8058/?name=arnold&count=50&residence=exeter-otsego&residence_x=1-0) : accessed 24 Nov 2020).

<sup>105</sup> 1840 U.S. census, Otsego County, New York, population schedule, Unadilla, p. 211, line 7, Charles Arnold; image, *Ancestry* ([https://www.ancestry.com/imageviewer/collections/8057/images/4409546\\_00427](https://www.ancestry.com/imageviewer/collections/8057/images/4409546_00427) : accessed 24 Nov 2020); citing National Archives microfilm publication M704, roll 328.

<sup>106</sup> 1850 U.S. census, Otsego County, New York, population schedule, Unadilla, p. 378, dwelling 449, family 530, Charles Arnold household; image, *FamilySearch* (<https://www.familysearch.org/ark:/61903/3:1:S3HT-6313-6QC> : accessed 23 Nov 2020); citing National Archives microfilm publication M432, roll 580.

<sup>107</sup> 1855 New York state census, Otsego County, population schedule, Unadilla, E.D. 2, dwelling 15, family 17, Charles Arnold household; image, *Ancestry* ([https://www.ancestry.com/imageviewer/collections/7181/images/005207138\\_00388](https://www.ancestry.com/imageviewer/collections/7181/images/005207138_00388) : accessed 23 Nov 2020).

<sup>108</sup> Cayuga Co., New York, Wills Q:189-191.

records, and probate records. Extending his descendancy tree could also reveal additional atDNA matches in the *AncestryDNA* database.

### David Morise Arnold

Several DNA matches to TT2 descend from a man named David Morise Arnold (1809-1876).<sup>109</sup> Two of the matches are shown in table 7 below. They also match TT1. Their unlinked family trees lead to the hypothesis that they are a daughter and grandson of Frederick Earl Pulford.<sup>110</sup>

Table 7 - DNA Matches with Descendants of David Morise Arnold			
Matching Individuals	Hypothesized Relationship	Shared cM	Shared cM Prediction for Relationship <sup>a</sup>
D1 and TT2	4th cousins	49 cM	0-139 cM (average 35 cM)
D1 and TT1	4th cousins once removed	12 cM	0-126 cM (average 28 cM)
D2 and TT2	4th cousins once removed	47 cM	0-126 cM (average 28 cM)
D2 and TT1	5 <sup>th</sup> cousins	11 cM	0-117 cM (average 25 cM)

a. Bettinger and Perl, "The Shared CM Project 4.0 tool v4," DNA Painter.

Figure 8 shows the lines of descent from David Morise Arnold to DNA matches D1 and D2. It also shows the probable parents of David Morise Arnold.

Research in Great Bend, Susquehanna, Pennsylvania, found that David's parents were probably William Arnold and his wife Anna. David Arnold resided in Great Bend in 1840, with two neighbors with the surname Arnold: Nathan (age 20-30) and William (age 50-60). William Arnold was born about 1780-1790.<sup>111</sup> William's household included a female age 50-60, male age 15-20, and female age 15-20. William Arnold was old enough to be the father of both Nathan and William.

<sup>109</sup> *Find a Grave*, database and images (<https://www.findagrave.com/memorial/88709800/david-morise-arnold> : accessed 23 November 2020), memorial page for David Morise Arnold (22 Jan 1809–30 Mar 1876), Find a Grave Memorial no. 88709800, citing Fillmore Cemetery, Fillmore, Fillmore County, Minnesota, USA ; Maintained by Larry Albrecht (contributor 47309406), headstone photo by Butch Barton (contributor 48843642).

<sup>110</sup> "Marl Family Tree," created by user Carol Marl, "Public Member Trees," database, *Ancestry* (<https://www.ancestry.com/family-tree/tree/106160213/family/pedigree?cfpid=170050328834> : accessed 23 Nov 2020). See also "Robert Pulford Family Tree," created by user Robert Pulford, "Public Member Trees," database, *Ancestry* (<https://www.ancestry.com/family-tree/tree/72407580/family/pedigree?cfpid=30256583794> : accessed 23 Nov 2020).

<sup>111</sup> 1840 U.S. census, Susquehanna County, Pennsylvania, population schedule, Great Bend, p. 351, line 9, Nathan Arnold, line 10, William Arnold, line 17, David Arnold; image, *Ancestry* ([https://www.ancestry.com/imageviewer/collections/8057/images/4410690\\_00722](https://www.ancestry.com/imageviewer/collections/8057/images/4410690_00722) : accessed 23 Nov 2020); citing National Archives microfilm publication M704, roll 476.



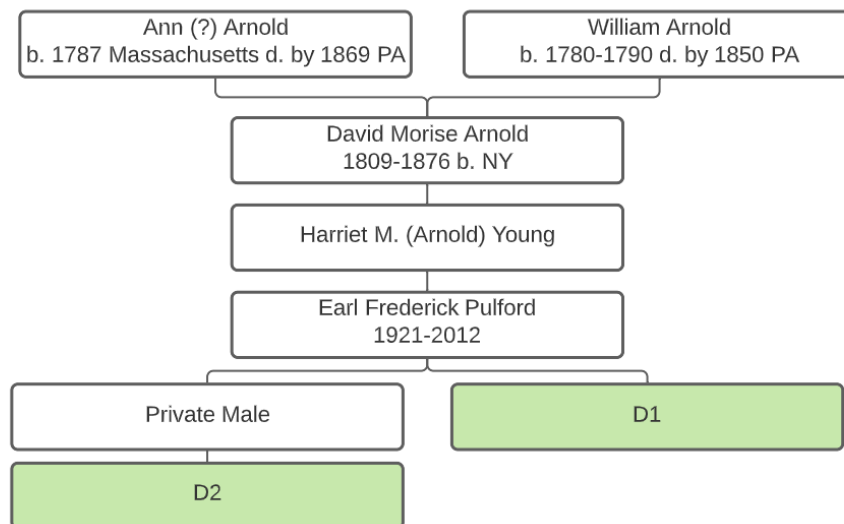

Figure 8 – DNA matches who descend from David Morise Arnold and his probable father, William Arnold<sup>112</sup>

David Arnold and inferred wife Hannah resided in Great Bend, Susquehanna County, Pennsylvania in 1850. David was age 41 (b. 1809) with a birthplace of New York.<sup>113</sup> Nathan Arnold lived next door, age 38, born in New York.<sup>114</sup> Since they were enumerated one after the other, indicating they were close neighbors, and both were born in New York around the same time, they could have been brothers.

Three households before from David on the 1850 census lived Norman D. Arnold, age 34, born in New York, and his inferred mother, Ann Arnold, age 63, born in Massachusetts.<sup>115</sup> Norman was also born in New York, near the time of David and Nathan's birth, and could have been their brother too.

Anna Arnold died in 1869 and her will was proved 29 June 1869. She bequeathed her estate to her son Norman Arnold, and if he died, to her son David Arnold.<sup>116</sup> This will provides evidence that Anna Arnold was the mother of David Arnold. Anna Arnold was probably the 50-60-year-old female in William

<sup>112</sup> For Earl Frederick Pulford's parents, see "Hagg Family Tree," Earl Fredrick Pulford (1921-2012), created by user klosbor, "Public Member Trees," database, Ancestry (<https://www.ancestry.com/family-tree/tree/11481946/family?cfpid=202052621032> : accessed 23 Nov 2020).

<sup>113</sup> 1850 U.S. census, Susquehanna County, Pennsylvania, population schedule, Great Bend, p. 386, dwelling 76, family 87, David Arnold household; Ancestry ([https://www.ancestry.com/imageviewer/collections/8054/images/4205392\\_00392](https://www.ancestry.com/imageviewer/collections/8054/images/4205392_00392) : accessed 23 Nov 2020).

<sup>114</sup> 1850 U.S. census, Susquehanna County, Pennsylvania, population schedule, Great Bend, p. 386, dwelling 77, family 88, Nathan Arnold household; Ancestry ([https://www.ancestry.com/imageviewer/collections/8054/images/4205392\\_00392](https://www.ancestry.com/imageviewer/collections/8054/images/4205392_00392) : accessed 23 Nov 2020).

<sup>115</sup> 1850 U.S. census, Susquehanna County, Pennsylvania, population schedule, Great Bend, p. 387, dwelling 73, family 84, Anna Arnold in Norman D. Arnold household; Ancestry ([https://www.ancestry.com/imageviewer/collections/8054/images/4205392\\_00391](https://www.ancestry.com/imageviewer/collections/8054/images/4205392_00391) : accessed 23 Nov 2020).

<sup>116</sup> Susquehanna County, Pennsylvania, Wills 3:335-6, Anna Arnold, 29 June 1869; image, FamilySearch (<https://www.familysearch.org/ark:/61903/3:1:3Q57-89SM-W1Q4> : accessed 14 Nov 2020).

Arnold's 1840 household, so he was probably the father of David Arnold, Nathan Arnold, and Norman Arnold. There were no other Arnolds living in Great Bend, Susquehanna, Pennsylvania in at this time.<sup>117</sup>

Because William Arnold was born from 1780-1790, it's not likely that he was a son of Amasa Arnold, who likely married Chloe Woodward in 1793. He is more likely to be a brother, making the DNA match D1 a fourth cousin to TT2. David Morise Arnold was probably a cousin of Daniel Arnold, not a sibling. See figure 9.

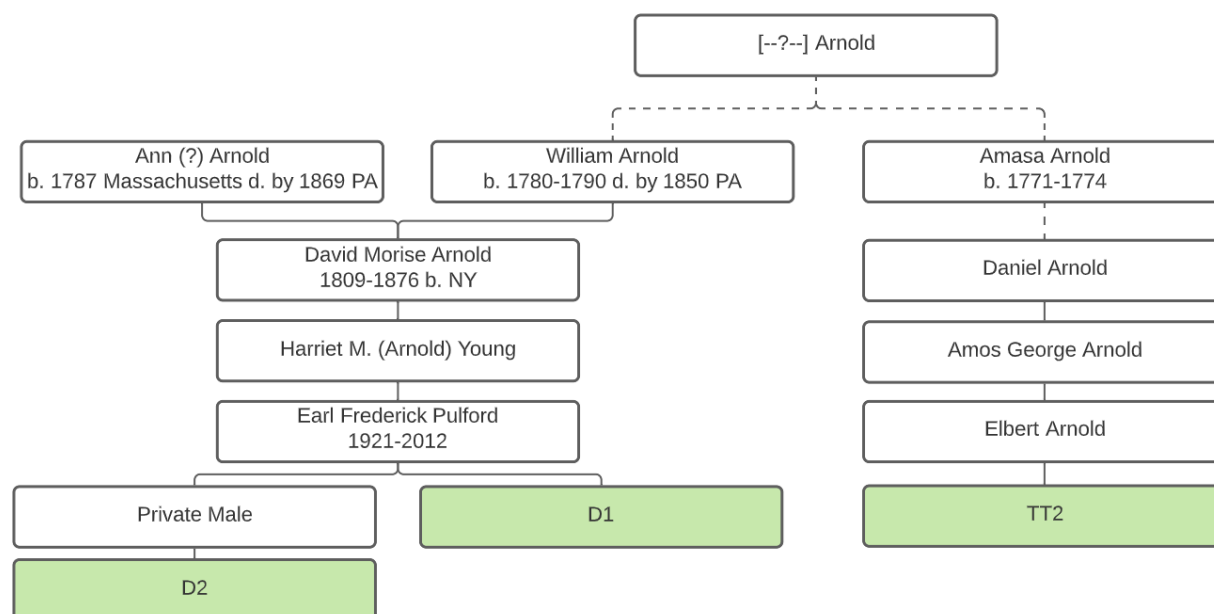

Figure 9 - Hypothesized relationship of William Arnold and Amasa Arnold

D1 and D2, descendants of David Morise Arnold, were found in TT2's network graph in cluster 12. Cluster 12 is also the location of Charles Arnold's descendant, H1. Cluster 12 is closely connected to cluster 16 which includes known Arnold descendants, and cluster 0 which includes Clarissa Arnold's descendant, C1. This indicates that David Morise Arnold is probably a relative of Daniel Arnold, Clarissa Arnold, and Charles Arnold. See figure 10 for TT2's network graph with hypothesized common ancestors plotted.<sup>118</sup>

Future research could examine the hypothesis that William Arnold was a brother of Amasa Arnold by searching for him in earlier census records prior to 1840 and searching in Massachusetts for marriage and birth records.

<sup>117</sup> "1840 United States Federal Census," search results for Arnold in Great Bend, Susquehanna, Pennsylvania, Ancestry (<https://www.ancestry.com/search/collections/8057/> : accessed 24 Nov 2020).

<sup>118</sup> Nicole Dyer, TT2's AncestryDNA Network Graph, 15-260 cM.

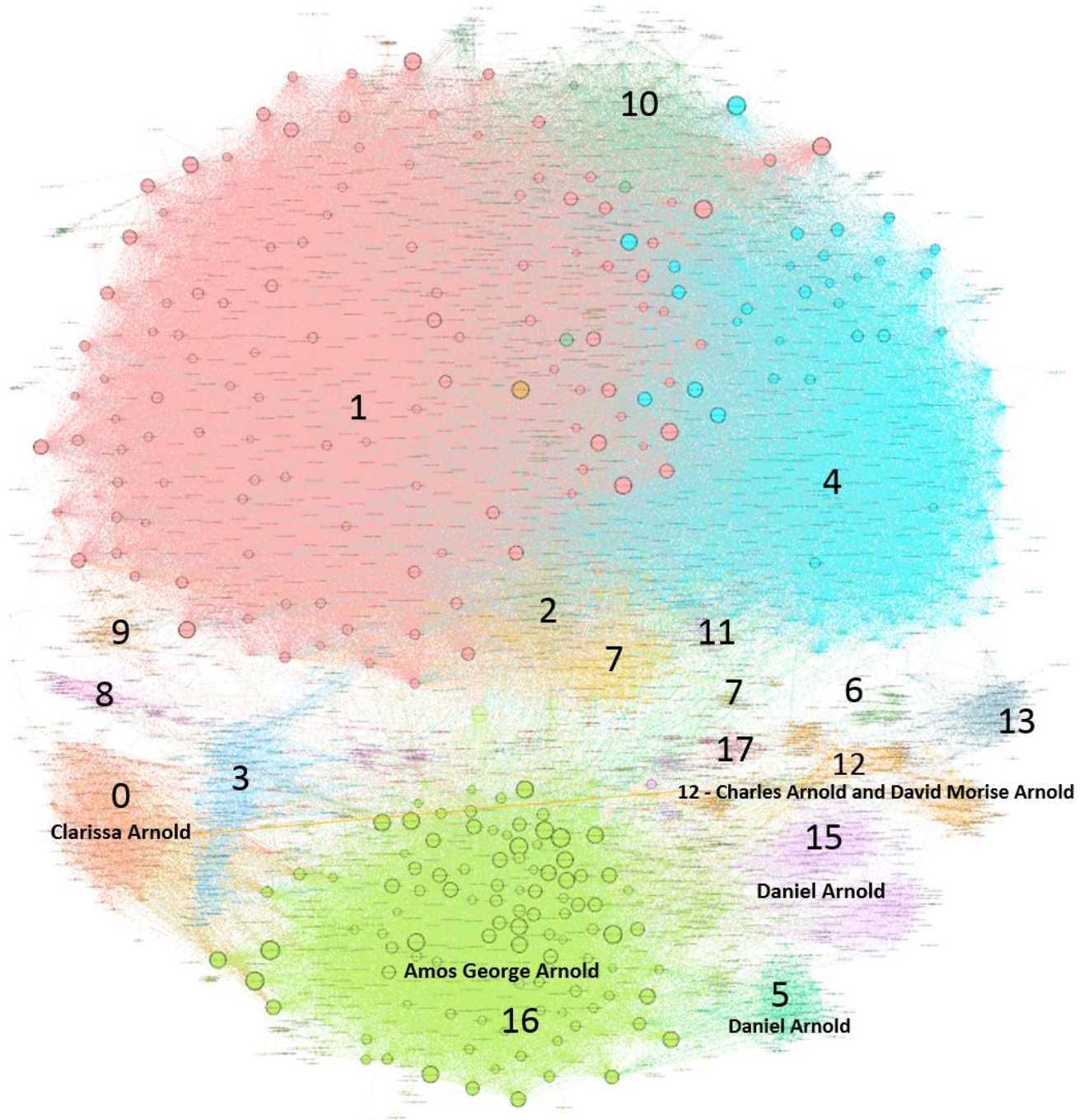

Figure 10 – TT2’s network graph annotated with Arnold DNA matches; connection between group 0 and 12 highlighted

## Y-DNA Results

The Y-37 test results of TT1 showed a match with TT12 of genetic distance 1 whose earliest known ancestor is Daniel Arnold, b. 1806. TT1 and TT12 are first cousins, with Elbert Arnold as their common

ancestor. Screenshots of TT12's Y-67 match list were shared with the researcher. A genetic distance of "1" means that there was a mutation between TT1 and/or TT12 and their grandfather, Elbert Arnold.

TT1's next closest match, M1, is a genetic distance of 1, comparing 37 markers. M1 is also a match to TT12 with a genetic distance of 0, comparing 67 markers.<sup>119</sup> This probably means the mutation that caused a genetic distance of 1 between TT1 and TT12 probably occurred between Elbert Arnold and his son Keith (TT1's father), or between Keith and TT1.

The match between TT12 and M1 with a genetic distance of one is very close. *FamilyTreeDNA* states that a common ancestor can be found 90% of the time within five generations:

*A 67/67 match between two men who share a common surname (or variant) means they share a common male ancestor within the genealogical time frame. Their relatedness is extremely close. All confidence levels are well within the time frame that surnames were adopted in Western Europe with the common ancestor predicted, 50% of the time, in three generations or less and with a 90% probability within five generations. Very few people achieve this close level of a match.*<sup>120</sup>

Tracing M1's patrilineal line could reveal a father, grandfather, or great-grandfather of Daniel Arnold. M1's tree included his grandfather, George James Arnold (1895-1976).

George James Arnold was used as the starting point for research to find additional ancestors in M1's patrilineal line. Known information about George James Arnold from M1's tree included:

- Born 1895 in Chicago, Cook, IL
- Died 1976 in Santa Cruz, Monterey, California
- Married Agnes Kirkman (1900-1987)

An indexed entry for an Illinois birth certificate was found for James George Arnold, born 25 October 1895 in Chicago, listing parents Harry Gilman Arnold and Anna Stata Hoyne.<sup>121</sup>

The 1900 census in Chicago also connects four-year-old George Arnold to his parents Harry Arnold and Anna S. Arnold. Included in the household was Harry Arnold's mother, Alice Arnold.<sup>122</sup>

---

<sup>119</sup> "Y-DNA matches," database report, *FamilyTreeDNA*, M1 and TT12, 67 markers, genetic distance 0; screenshot, "[TT2's] Matches," email to Nicole Dyer (nicoleedyer@gmail.com), 13 Aug 2020. **Attachment 2.**

<sup>120</sup> "If two men share a surname, how should the genetic distance at 67 Y-chromosome STR markers be interpreted?" *FamilyTreeDNA Learning Center* (learn.familytreedna.com : accessed 13 Nov 2020).

<sup>121</sup> "Cook County, Illinois, U.S., Birth Certificates Index, 1871-1922," James George Arnold, 25 Oct 1895, Chicago; database, *Ancestry* (<https://www.ancestry.com/search/collections/2545/> : accessed 23 Nov 2020).

<sup>122</sup> 1900 U.S. census, Cook County, Illinois, population schedule, Chicago Ward 27, District 822, p. 27A, house 472, family 508, George Arnold in Harry Arnold household; image, *Ancestry* ([https://www.ancestry.com/imageviewer/collections/7602/images/4113737\\_00183](https://www.ancestry.com/imageviewer/collections/7602/images/4113737_00183) : accessed 23 Nov 2020).

1900 Census Harry Arnold Household, Chicago, Cook, Illinois					
Name	Relationship to head	Birthdate	Birthplace	Birthplace of father	Birthplace of mother
Harry Arnold	Head	Feb 1871	Illinois	Rhode Island	New York
Anna S. Arnold	Wife	Jan 1868	Ireland	Ireland	Ireland
George Arnold	Son	Oct 1895	Illinois	Illinois	Ireland
Alice Arnold	Mother, wd	Dec 1837	New York	Massachusetts	Massachusetts

Harry Gilman's father was born in Rhode Island, according to this census. A search for Harry Gilman Arnold on the 1880 census did not return a census with a nine-year-old Harry and his parents. However, a widower named A. Arnold living with son Harry Arnold, age 9, was located. The following details were learned:

- A. Arnold, listed as male, age 39 (b. 1841), widow, born in NY, parents born in NY
- Harry Arnold, male, age 9, son, single, born in Illinois, father born [R???], mother born in NY
- Address: 34 N. Clark Street

Harry Gilman's father's name may be listed on his death record. Death records for Harry Gilman Arnold were searched. A funeral home record was located for Harry G. Arnold, b. 22 Feb 1871 in Illinois, d. Apr 1959 San Francisco, with parents James Arnold and Alice Aymes.<sup>123</sup>

Death and probate records were searched in Cook County, Illinois for James Arnold, dying between Harry Gilman Arnold's birth in 1871 and the 1880 census. A probate record was found for James W. Arnold on 6 Aug 1880, with Almenia A. Arnold, administratrix. It stated that James W. Arnold, resident of Cook County, had died 6 September 1879, intestate. A helpful clue was that Almenia A. Arnold resided at 34 N. Clark St, the same location as the 1880 census of A. Arnold and son Harry.<sup>124</sup> A census record was found for James Arnold living alone in Chicago in 1870, age 30 (b. 1840). His occupation was carpenter and birthplace was Rhode Island.<sup>125</sup>

A death record was found for James Whipple Arnold in Providence, Rhode Island, died 6 September 1879, to be buried in Chicago, Illinois. This is the same date as the probate record in Chicago, tying him to the

<sup>123</sup> "California, San Francisco Area Funeral Home Records, 1895-1985," H.F. Suhr Company, case no. 24567, 30 Apr 1959, Harry G. Arnold; image, *Ancestry* (<https://www.ancestry.com/imageviewer/collections/2118/images/B020328-00373> : accessed 26 Oct 2020).

<sup>124</sup> "Illinois, U.S., Wills and Probate Records, 1772-1999," Cook County, letter of administration, James W. Arnold, 6 August 1880; image, *Ancestry* ([https://www.ancestry.com/imageviewer/collections/9048/images/007654215\\_00142](https://www.ancestry.com/imageviewer/collections/9048/images/007654215_00142) : accessed 23 Nov 2020).

<sup>125</sup> 1870 U.S. census, Cook County, Illinois, population schedule, Chicago Ward 1, p. 36, dwelling 204, family 412, James Arnold; image, *FamilySearch* (<https://www.familysearch.org/ark:/61903/3:1:S3HT-DYKS-LLG> : accessed 24 Nov 2020); citing National Archives microfilm publication M593, roll 198.



probate record and to Almenia Alice (Aymes) Arnold and son Harry Arnold. The death return provided the following information:<sup>126</sup>

- James died at age 42 years, 0 months, and 6 days (born 31 Aug 1837)
- James was married at the time of death
- James was a cabinet maker
- James was born at Smithfield, Rhode Island
- James' parents were Welcome Arnold and Amey B. Arnold, both born in North Providence

Perhaps James W. Arnold was visiting family in Smithfield when he died. The fact that he was to be buried in Chicago further matches him to the James Arnold of Chicago, as well as their occupations: carpenter and cabinet maker, which are similar.

An *Ancestry* public member tree created by the researcher shows the parent-child links between James George Arnold and his patrilineal line: Harry Gilman Arnold, James Whipple Arnold, and Welcome Arnold.<sup>127</sup> Welcome Arnold and Amey B. Whipple, of Smithfield, Rhode Island, were located in the *FamilySearch Family Tree* to extend the patrilineal line of M1. Welcome Arnold's patrilineal line extends several generations back to Thomas Arnold (1608-1674) of Watertown, Middlesex, Massachusetts.<sup>128</sup> No connection has yet been found for Daniel Arnold or his hypothesized father Amasa Arnold to this patrilineal line. See Figure 11.

Future research could examine each parent-child link in the *FamilySearch Family Tree* between Welcome Arnold and Thomas Arnold and check for accuracy. Descendancy research could be done with Welcome Arnold, his father, and grandfather, to see if any patrilineal descendants had a son named Amasa who could be the same as the Amasa Arnold who lived in Saratoga and Otsego Counties, New York, or another potential father for Daniel Arnold.

---

<sup>126</sup> Providence, Rhode Island, Return of Death, James Whipple Arnold, 6 September 1879; image, *FamilySearch* (<https://www.familysearch.org/ark:/61903/3:1:3Q57-L9VD-JH46> : accessed 23 Nov 2020).

<sup>127</sup> "Arnold Family Tree," created by user Nicole Elder Dyer, "Public Member Trees," *Ancestry* (<https://www.ancestry.com/family-tree/tree/172196512/family?cfpid=202230696660> : accessed 23 Nov 2020).

<sup>128</sup> Welcome Arnold, ID KZH6-G29, "Family Tree," *FamilySearch* (<https://www.familysearch.org/tree/pedigree/landscape/KZH6-G29> : viewed 18 Nov 2020).

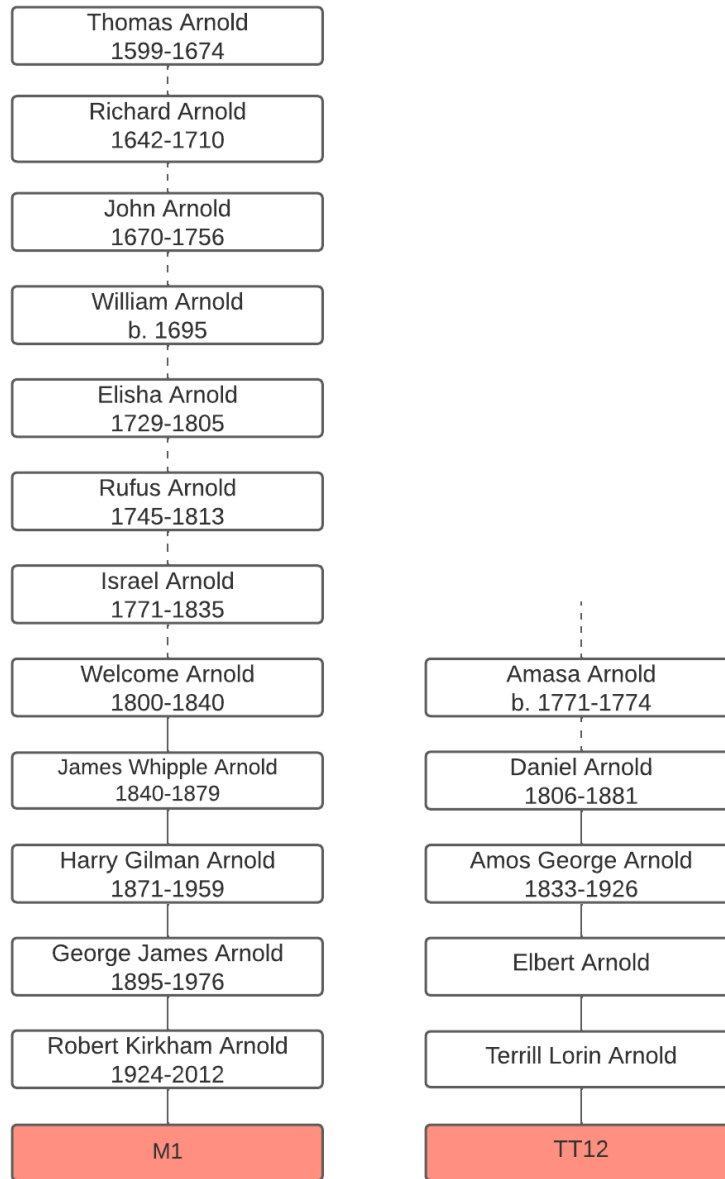

Figure 11 - Y-DNA patrilineal lines of M1 and TT12

## Conclusion

Records of Daniel Arnold’s life that provide clues to his family of origin were examined. Amasa Arnold of Exeter, Otsego County, New York was explored as a possible father for Daniel Arnold. Records show he is a likely candidate. His likely son, Amos Arnold, was researched. Amos Arnold’s probate proceedings included a list of three next-of-kin and heirs, possibly siblings: Charles Arnold, Clara Mason, and Elizabeth Adams. DNA matches were found to descendants of Charles Arnold and Clarissa Mason. Future research could find more about Elizabeth Adams. Future research could also include a census study with

Amasa Arnold's 1800-1830 households correlated with the ages of possible children Charles, Clarissa, Elizabeth, Amos, and Daniel.

Autosomal DNA identified matches to descendants of David Morise Arnold, whose father was probably William Arnold. William is a possible sibling to Amasa Arnold. Y-DNA identified a close match whose patrilineal line extends back to Thomas Arnold (1608-1674) of Watertown, Middlesex, Massachusetts. Daniel Arnold will likely be found to be a descendant of Thomas Arnold in future research.

## Future Research Suggestions

- Find Arnold DNA matches at other databases, including at *GEDmatch*, *MyHeritage* and *FamilyTreeDNA*
- Examine the parent-child links of TT1's close Arnold *AncestryDNA* matches in Figure 1 for accuracy.
- Otsego County, New York, County Clerk. "Deed records, 1791-1901." *FamilySearch*. (<https://www.familysearch.org/search/catalog/242628>).
  - Search for "D Arnold" who lived next to "A Arnold" in the 1810 Exeter, Otsego County, New York census.
  - Search for Amasa Arnold's census neighbors to find if he was listed as a neighbor on other deeds which could determine when he arrived in Exeter.
  - Search for Charles Arnold.
- Otsego County, New York, Surrogate Court. "Wills and administrations, 1792-1902." *FamilySearch*. (<https://www.familysearch.org/search/catalog/228907>).
  - Search for "D Arnold" who lived next to "A Arnold" in the 1810 Exeter, Otsego County, New York census.
  - Search for Charles Arnold.
- Search Otsego County Surrogate court records for Amasa Arnold. Images to browse online:
  - Otsego County, New York Surrogate Court. "Real estate proceedings, 1813-1832." *FamilySearch*. (<https://www.familysearch.org/search/catalog/17980>).
  - Otsego County, New York Surrogate Court. "Miscellaneous records, 1781-1877." *FamilySearch*. (<https://www.familysearch.org/search/catalog/17991>).
- New York Secretary of State. "Patents of the State of New York 1664–1912." *FamilySearch*. <https://www.familysearch.org/search/catalog/629503>. Only available at *FamilySearch* Library or satellite centers. Search for Amasa Arnold prior to 1840.
- New York. Secretary of State. "Grantee Card Index to Deeds, abt 1640–1973." *FamilySearch*. (<https://www.familysearch.org/search/catalog/634818>). Only available at *FamilySearch* Library or satellite centers. Search for Amasa Arnold prior to 1840.
- Cayuga County, New York. "Deed records, 1794-1901." *FamilySearch* (<https://www.familysearch.org/search/catalog/224673>). Search for Amos Arnold about 1844-1866.
- Find Clarissa Arnold and Nehemiah Mason in pre-1850 census records



- Find the common ancestors of additional matches in cluster 0, hypothesized as a cluster of matches associated with Clarissa Arnold.
- Find Elizabeth (Arnold) Adams, probable sister to Amos Arnold, born 1790-1810 in NY, maybe living in New York, Michigan, or Wisconsin, in census records, beginning with 1850.
- Search Charlton, Worcester, Massachusetts town records for Amasa Arnold and Chloe Woodward:
  - Charlton, Massachusetts. "Town records, 1755-1865." *FamilySearch*. (<https://www.familysearch.org/search/catalog/279412>). Only available at *FamilySearch* Library or satellite centers
    - v. 1-4, records of town meetings, finances, elections, estrays, and lists of men enrolled in the militia 1755-1857
    - Town financial records and school financial records 1784-1865
  - Charlton, Massachusetts. "Vital and town records ca. 1714-1859, Charlton, Massachusetts." Vital and town records ca. 1714-1859. *FamilySearch*. (<https://www.familysearch.org/search/catalog/47454>). Images to browse online.
- Research descendants of Chloe Woodward's siblings listed in the *FamilySearch Family Tree* and check for atDNA matches who descend from Woodward relatives.
- Review the parent-child links in the following trees for accuracy:
  - "Germond Family Tree," created by user PJohnston34, "Public Member Trees," database, *Ancestry* (<https://www.ancestry.com/family-tree/tree/43533507/family/pedigree?cfpid=12670954504>). Check C1's descent from Clarissa Arnold.
  - "Ripley Family Tree," created by user Charlotte542013, "Public Member Trees," database, *Ancestry* (<https://www.ancestry.com/family-tree/tree/83747969/family/pedigree?cfpid=48487057528>). Check H2's descent from Charles Arnold.
  - H1's line of descent from Charles Arnold as given in a message: H1 < Mother < Samuel Wright < Charles Henry Wright < Ann C Arnold < Charles Arnold.
  - "Hagg Family Tree," created by user klosbor, "Public Member Trees," database, *Ancestry* (<https://www.ancestry.com/family-tree/tree/11481946/family?cfpid=202052621032>). Check parent-child links between D2 and David Morise Arnold.
- Determine the common ancestors of group 12 in TT2's network graph to see if that cluster contains additional descendants of Charles Arnold.
- Research Charles Arnold in census records for after 1855, cemetery records, probate records, and extend his descendant tree to reveal additional atDNA matches in the *AncestryDNA* database.
- Find William Arnold, probable father of David Morise Arnold, in census records before 1840.
- "Massachusetts, U.S., Town and Vital Records, 1620-1988." *Ancestry*. (<https://www.ancestry.com/search/collections/2495/>).
  - Birth of William Arnold
  - Marriage of William Arnold and Anna

- Descendancy research for Welcome Arnold, his father, and grandfather, to see if any patrilineal descendants had a son named Amasa in Massachusetts who could be the same as the Amasa Arnold who lived in Saratoga and Otsego Counties, New York.
- Correlate ages and genders from Amasa Arnold's 1800-1830 households in Exeter with the ages of possible children Charles, Clarissa, Elizabeth, Amos, and Daniel.

## Attachment 1 – Amos Arnold Will Transcript

Cayuga County, New York, Wills Q:189-191, Amos Arnold, 1866; image, *FamilySearch* (<https://www.familysearch.org/ark:/61903/3:1:33S7-9YC6-LS3> : accessed 21 Nov 2020).

[Note: The bottom and edges of the will book images are dark and smudged, making some text at the edges of the paper difficult to read.]

To the Surrogate of the County of Cayuga: the petition of Emily J. Arnold of the town of Brutus county of Cayuga & state of New York respectfully sheweth that Amos Arnold late of the town of Brutus in the county of Cayuga aforesaid departed this life on or about the sixth day of June in the year of our Lord one thousand eight hundred and sixty-six. That the said dec'd was at the time of his death an inhabitant of the said county of Cayuga, that he has left a last will & testament which is dated the 18th day of April in the year of our Lord one thousand eight hundred and sixty-five. That in & by the said will the said dec'd appointed Emily J. Arnold your petitioner sole Executor thereof, that the said dec'd left the following heirs at law & next of kin to wit: Arnold whose first name your petitioner does not know & cannot after due diligence & enquiry ascertain, Charles Arnold, Clara Mason, Elizabeth Adams & other persons to your petitioner unknown, & your petitioner does not know & cannot after diligent enquiry ascertain the ages or places of residence of any of the foregoing named persons, but supposes ^that^ they reside somewhere in the states of Michigan & Wisconsin. Said will relates to both real & personal estate & the real estate is worth about eight hundred dollars & the personal estate about twelve hundred dollars. That your petitioner is desirous of following said last Will & testament as a will of real & personal estate that the same may be recorded as such in pursuance of the statute in such case made & provided. Your petitioner therefore prays the Surrogate aforesaid that the necessary steps may be taken before him for that purpose. Emily J. Arnold, Cayuga County as: The above petitioner being sworn deposes & says that the facts stated in the above petition by her signed are true to the best of her knowledge & belief, Emily J. Arnold. Sworn this 30 day of Jun 1866 before me J.M. [Davis?]

aforesaid Surrogate of Cayuga Co. The people of the state of New York to \_\_\_\_ Arnold, Charles Arnold, Clara Mason, Elizabeth Adams & others whose places of residence are unknown & cannot after diligent enquiry be ascertained heirs at law & next of kin of Amos Arnold late of the town of Brutus Cayuga county dec'd [??? ????? (smudged)] Whereas Emily J. Arnold of Brutus N.Y. has lately applied to our Surrogate of the county of Cayuga for the proof of the will of Amos Arnold late of Brutus in said county decd which said will relates to both real & personal estate therefore you & each of you are cited & required to appear at [the? court?] of the said Surrogate in the city of Auburn on the [21st? day of August next [at ??? ??]] [ternoon?] of that day & attend the probate of the [said?] [Will?] [In?] [????? ????? (smudged)] [the?] seal of office of our said Surrogate to be hereunto affixed (L.S.) [T???? ??? ??? (smudged)] [rogate?] of the county of Cayuga at the [Surrogate office? in the city of Auburn? ??? (smudged)] July, in the year of our Lord one thousand eight hundred and [sixty six? ??? ??? (smudged)]

[page 190]

Surrogate State of New York city & county of Albany as: George W. Quackenbush [of?] of Albany being duly sworn says that he is a Foreman in the office of the Albany [E??] Journal, the State Paper published in the city of Albany & that the Notice of which [iss-?] used is a printed copy has been regularly published in said Albany Evening [journal?] once in each week for six weeks successively commencing on the fifth day of July 1866 Geo W. Quackenbush. Sworn before me this 16th day of August 1866 Pte Van Eyck [Coun? ??] [miner?] of deeds.

At a Surrogate's Court held at the Surrogates' office in the city of Auburn in & for the county of Cayuga on the 24th day of August A.D. 1866

Present Wm B. Woodin Surrogate

An Instrument in writing purporting to be the last will & testament of Amos Arnold late of the town of Brutus in said county dec'd was offered for proof & probate as a will of real & personal estate pursuant to the statute in such case made & provided. On filing due proof of the publication & service of the citation heretofore issued in this matter upon the heirs at law & next of kin of said dec'st as required by law. It is ordered that this matter be now brought on to be heard & both of the subscribing witnesses to said Will were provided in open court & certified as follows:

In the matter of the proof & } Cayuga County as: John F. M. Davis of the town  
 probate of the last will & testa- } of Brutus in said county being duly sworn says I  
ment of Amos Arnold dec'st } was well acquainted with Amos Arnold late of  
 the town of Brutus in the county of Cayuga aforesaid and I was present when a certain instrument in writing now here shown to me bearing date the 18th day of April A.D. 1865 & purporting to be the last will & testament of the said dec'd was executed. I saw the dec'd execute the same by signing his name at the end thereof & heard him publish & declare the same to be his last will & testament the dec'd requested me to become a subscribing witness to the execution thereof I did so & signed my name thereto as such witness in his presence. The dec'd [was?] in my opinion at the time of the execution of said instrument of a sound & disposing mind & memory & in all respects competent to make & publish a last will & testament & to devise real estate; that he was of full age & under no restraint that I know of. I drew the Will at the request of the dec'd, it is the same now in all respects as when executed by the dec'd. J. M. Davis. Subscribed & signed to the 24th day of Aug A. D. 1866 before me Wm B. Woodin Surrogate.

In the matter of the proof & } Cayuga County as: Jacob Waggoner of the town of [Bru-?]  
 probate of the last will & testa- } tas in said County being duly sworn says: I [was?]  
ment of Amos Arnold dec'd } well acquainted with Amos Arnold late of [the town?]  
 of Brutus in the county of Cayuga aforesaid dec'd, I was present with a [certain?]  
 instrument in writing now here shown to me bearing date the 18th day [??]

[page 191]

A.D. 1865 & purporting to be the last will & testament of the said [???? (smudged)] the dec'd execute the same by signing his name at the end thereof & heard him [publish?] & declare the same to be his last will & testament. The dec'd requested me to become a subscribing witness to the execution thereof I did so & signed my name as such witnessed in his presence. The said dec'd was in my opinion at the time of the [execu-?] tion of said instrument of a sound & disposing mind & memory & in all respects compe tent to make & publish a last will & testament & to devise real estate that he was of full age & under no restraint that I know of. Jacob Waggoner. Subscribed & sworn to this 24th day of August A.D. 1866 before me Wm B. Woodin Surrogate Cayuga county as: Emily J. Arnold being duly sworn says that she will well honestly & faithfully discharge the duty of executrix of the last will & testament of Amos Arnold dec'd according to law. Mrs. Emily J. [Waterman?] Sworn & subscribed this 24th Aug 1866.

## Will

I Amos Arnold of the town of Brutus Cay. Co NY aged 67 years & upwards & being of sound & disposing mind & memory do hereby make and publish & declare this to be my last will & testament as follows. I give devise & bequeath unto my wife Emily J. Arnold all my estate both real & personal of every name & nature of which I shall die seized or possessed. And I hereby appoint my said wife Emily J. Arnold the sole Executrix of this my last will & testament & hereby revoke all former wills by me made In witness whereof I have hereunto set my hand this 18th day of April 1875 Amos Arnold (L.S.) The foregoing instrument consisting of one half sheet of paper was in our presence signed by Amos Arnold & by him declared to each of us to be his last will & testament & he requested each of us to sign our names hereto as subscribing witnesses & we have hereto in the presence of Amos Arnold & of each other signed our names as such witness  
J.M. Davis Weedsport N.Y. Jacob Waggoner.

I hereby certify that the preceding is a true record of the proceedings proofs & executions had before me in the matter of the proof and probate of the last will and testament of Amos Arnold late of the Town of Brutus in the county of Cayuga dec'd as a will of real & personal estate & also the said will & that the same was recorded August 24th 1866  
Wm. B Woodin  
Surrogate

# Attachment 2 – TT12 Y-DNA Matches

“Y-DNA matches,” database report, FamilyTreeDNA, M1 and TT12, 67 markers, genetic distance 0; screenshot, “[TT12’s] Matches,” email to Nicole Dyer (nicoleedyer@gmail.com), 13 Aug 2020.



Nicole Dyer <nicoleedyer@gmail.com>

**Fwd: TT12's Matches.**

To: Dyer Nicole <nicoleedyer@gmail.com>

Sun, Aug 16, 2020

FYI

Begin forwarded message:

**From:** [Redacted]  
**Date:** August 13, 2020 at 4:39:24 PM MDT  
**To:** [Redacted]  
**Subj:** [Redacted]

Distance	Name	Earliest Known Ancestor	Haplogroup	SNP	Date
↑					
0	<b>M1</b> Arnold Y-DNA67 FF		R-M269		3/1/2018
1	<b>TT1</b> Arnold Y-DNA37	Daniel Arnold 1806-1881 of New York	R-M269		7/1/2020